

Your Essential Resource for

INFINITYLAB LC SUPPLIES





Agilent
CrossLab

From Insight to Outcome

**ACROSS THE LAB, AROUND THE WORLD,
WITH YOU EVERY STEP OF THE WAY.**

Real stories from the lab.

WHO WE ARE. WHAT WE DO.

Whatever your lab needs, Agilent CrossLab is ready to partner with you to create new and transformative opportunities. Together, we'll support your scientific and business goals with superior laboratory services, software, and consumables from Agilent. A direct connection to a global team of service experts delivers vital, actionable insights at every level for your lab.

Our solutions maximize performance, reduce complexity, and drive improved economic, operational, and measurable outcomes. And our innovative and comprehensive products generate immediate results and lasting impact.

Look out for CrossLab stories from the lab to find out how we can help.

Get the full story at
www.agilent.com/chem/CrossLabStories

INFINITYLAB LC SUPPLIES

MAXIMIZE THE EFFICIENCY OF YOUR LC WORKFLOWS

The InfinityLab family is an optimized portfolio of LC instruments, columns, and supplies designed to work together seamlessly for maximum efficiency and performance—regardless of application area. Supporting your efforts to increase your analytical, instrument, and laboratory efficiency in your everyday work.



Achieve optimal LC performance with simplified laboratory solutions

From routine analysis to cutting-edge research, the InfinityLab family gives you the ability to:

- Maximize performance and efficiency of your LC workflows with the latest innovations
- Reduce costs with more efficient lab operations
- Easily identify the columns and supplies that work best with your Agilent InfinityLab LC Series instruments

The InfinityLab family provides the solutions you need to optimize your LC performance and achieve the highest operational efficiency.

InfinityLab supplies

The small parts of your workflow make a big difference in the quality of your results. Agilent InfinityLab supplies are a range of innovative consumables designed to optimize your liquid chromatography workflows. From maintaining your LC system, to controlling harmful solvent fumes, these innovative supplies solve your everyday laboratory problems. InfinityLab supplies enable you to work more efficiently, leaving you with more time and less frustration.



TABLE OF CONTENTS

FEATURED PRODUCTS	1
INSTRUMENT AND MODULE KITS	3
PUMP SUPPLIES	13
AUTOSAMPLER SUPPLIES	28
FRACTION COLLECTOR SUPPLIES	42
TCC/MCT AND VALVE SUPPLIES	47
DETECTOR SUPPLIES	71
BIO-INERT SUPPLIES	82
PURIFICATION SUPPLIES	86
GENERAL SUPPLIES	91
LC CAPILLARIES	97
LC COLUMNS	128
LC SYSTEMS	134
AGILENT SOLUTIONS, SERVICES, AND SUPPORT	140

Featured Products

Agilent 1260 Infinity II Prime LC

Achieve the highest convenience for your everyday analysis

The Agilent 1260 Infinity II Prime LC is the most capable and convenient LC within the 1260 Infinity II LC portfolio. Featuring an extended pressure range of up to 800 bar, enhanced quaternary mixing, and superior Agilent 1290 Infinity II technology it offers the highest ease-of-use and functionality for your everyday analysis.

- The 1260 Infinity II Flexible pump features an extended pressure range of up to 800 bar and superior quaternary mixing. Perfectly matching InfinityLab Poroshell 120 columns take you one step further in your everyday work enabling higher precision and accuracy.
- The InfinityLab LC Companion lets you access and control your instrument comfortably from your office or other locations
- The multiwash capability of the 1260 Infinity II multisampler cleans all relevant injection parts between runs for ultralow carryover. This sophisticated, integrated feature flushes the injection needle outside with three solvents and uses seat backflush procedures to reduce carryover to less than 10 ppm.
- Using shallow well-plate drawers, the 1260 Infinity II multisampler takes a maximum load of 16 microplates and up to 6,144 samples, the most of any single system for efficient sample handling and logistics
- The 1260 Infinity II MCT holds up to four columns with direct access to each column through a InfinityLab Quick Change switching valve, eliminating the need to disconnect and reconnect columns
- The Multipurpose valve allows you to purge your instrument via software, reducing the need for manual interaction
- BlendAssist delivers accurate buffer/additive blending without manual interaction for simplified workflows
- Intelligent System Emulation Technology (ISET) facilitates seamless transfer of methods between LCs regardless of the brand, delivering unchanged retention time and peak resolution
- Agilent's Instrument Control Framework (ICF) enables smooth control of Agilent LC instrumentation through third-party chromatography data systems
- Triple your sample capacity within the footprint of the 1260 Infinity II prime with the incredibly powerful Ultivo Triple Quadrupole LC/MS

Note: Take full advantage of the speed and performance capabilities of the Infinity II Prime LC system with 1000 bar rated InfinityLab Poroshell 120 columns. Robust 2.7 μm Poroshell particles operate at reduced backpressure, allowing high flow rates to be used for optimal separation efficiency and fast analysis. Turn to **Page 128** for details.



FEATURED PRODUCTS

InfinityLab Capillary and Convenience Kits

Quickly access the essentials you need for optimal performance of your InfinityLab LC Series instrument.

Turn to **Page 3** or visit www.agilent.com/chem/capillaryfittingkits



InfinityLab Stay Safe Caps

Simplify every day solvent handling, safely and more reliably, with Stay Safe caps and ergonomic solvent bottles.

Turn to **Pages 25–26** or visit www.agilent.com/chem/staysafecaps

InfinityLab Quick Connect/Quick Turn Fittings

These award-winning fittings offer easy, leak-proof connections for every user, every time.

Turn to **Pages 103–106** or visit www.agilent.com/chem/infinitylabfittings



Smart InfinityLab Supplies

Automatically recognized by your InfinityLab LC Series instrument, these supplies provide critical information and full usage traceability for less downtime, greater operational efficiency, and confidence in results. Supplies include:

- InfinityLab Column ID tag
- InfinityLab Long Life HiS deuterium lamps with RFID tag
- InfinityLab Max-Light cartridge cells with RFID tag

Turn to **Pages 47–48, 72, 76** or visit www.agilent.com/chem/infinitylab

InfinityLab Poroshell 120

Agilent InfinityLab Poroshell 120 columns work seamlessly with InfinityLab LC Series supplies and instruments. These columns are available with a preprogrammed ID tag, allowing you to get the most from your column and instrument.

Turn to **Pages 128–131** or visit www.agilent.com/chem/poroshell-120



INSTRUMENT AND MODULE KITS

InfinityLab Convenience Kits

A carefully selected portfolio of InfinityLab supplies for efficient ramp up usage of new InfinityLab LC Series instruments.

InfinityLab Capillary Kits

A complete set of system capillaries, including InfinityLab fittings available in 0.17 and 0.12 mm internal diameters.

System Kits

Description	Kit Contents	Part No.
Convenience Kits		
InfinityLab convenience kit, for 1260 Infinity II LC	Includes solvent bottles 1 L (3 clear, 1 amber), identification rings and removable stickers for solvent bottles, vials (2 mL) clear with bonded preslit caps (500/pk), solvent inlet filters stainless steel (4/pk), inline filter kit, multifunction tool, Stay Safe cap starter kit, and complete contents of 1260 Infinity II capillary kit (5067-6614)	5067-6617
InfinityLab convenience kit, for 1290 Infinity II LC	Includes solvent bottles 1 L (3 clear, 1 amber), identification rings and removable stickers for solvent bottles, vials (2 mL) clear with bonded preslit caps (500/pk), solvent inlet filters stainless steel (4/pk), inline filter kit, multifunction tool, Stay Safe cap starter kit, and complete contents of 1290 Infinity II capillary kit (5067-6615)	5067-6616
InfinityLab convenience kit, for 1260 Infinity II Bio-inert LC	Includes solvent bottles 1 L (3 clear, 1 amber), identification rings and removable stickers for solvent bottles, vials (2 mL) clear with bonded preslit caps (500/pk), solvent inlet filters glass (20 µm), multifunction tool, Stay Safe cap starter kit, and complete contents of 1260 Infinity II bio-inert capillary kit (5067-6621)	5067-6620

Capillary Kits

InfinityLab capillary kit, 0.17 mm, for 1260 Infinity II LC	Complete set of system capillaries, Quick Connect and Quick Turn fittings, PEEK finger-tight fittings, stainless steel restriction capillary, and blank nut	5067-6614
InfinityLab capillary kit, 0.12 mm, for 1290 Infinity II LC	Complete set of system capillaries, Quick Connect and Quick Turn fittings, PEEK finger-tight fittings, stainless steel restriction capillary, and blank nut	5067-6615
InfinityLab capillary kit, for 1260 Infinity II Bio-inert LC	Complete set of system capillaries, including Quick Connect fitting and UHP-FF fittings, PEEK finger-tight fittings, PEEK union, mounting tool for UHP-FF fittings, and blank nut	5067-6621

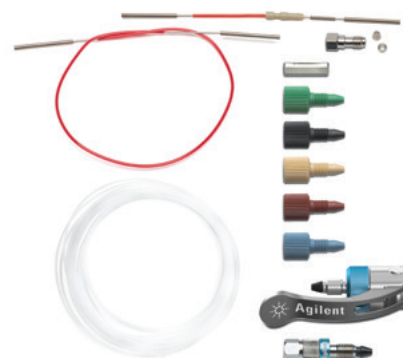

A selection of supplies from the InfinityLab capillary kit, 0.12 mm, for 1290 Infinity II LC



Preventive maintenance kit, for 1220 manual injector systems, G4280-68750



Preventive Maintenance Kits

Noisy baselines. Shorter column life. Lower analytical sensitivity. Variable retention times. Any – or all – of these problems can be caused by a lack of preventive maintenance. That’s why it’s critical to set up an LC instrument maintenance program, and to keep essential supplies in stock for regular replacement of worn or damaged components. You can keep LC pumps, autosamplers, and detectors operating at their best with Agilent preventive maintenance kits. These kits contain the seals, frits, stators, fittings, connections, and other components needed to maximize LC instrument uptime. As well as complete instructions on how to access parts for cleaning or replacement.

Pump Kits

Regular pump maintenance helps to lower operating costs and generate reliable results that you can trust.

You can count on Agilent isocratic, binary, quaternary, capillary, and preparative pumps for superior flow and composition stability. And by following a regular maintenance routine, you can also count on maximum uptime and a steady, accurate solvent flow for the life of the pump.

Routine Pump Maintenance Procedures

- Replace the seals and pistons
- Replace the PTFE frit
- Replace the cartridge in the active inlet valve
- Clean the outlet ball valve
- Clean or replace the solvent inlet frits

Routine pump maintenance should be done on a regular basis to keep your Agilent LC performing at its optimum. You can perform all maintenance procedures at once or as needed. Some parts may need to be replaced more than others depending upon your application and solvent preparation procedures.

Routine Pump Maintenance Procedures

Symptom	Cause	Solution
Solvent dripping out of waste outlet when valve closed	Leak on pump head	Exchange the purge valve frit or the purge valve
Pressure ripple unstable	Dirty active inlet valve cartridge	Run leak test for verification and exchange the active inlet valve cartridge
	Leak on pump head	Run leak test for verification and exchange the outlet ball valve sieve or the complete valve
Gradient performance problems, intermittent pressure fluctuations	Solvent filter is blocked	Change the solvent filter
A pressure drop of > 10 bar across the frit (5 mL/min H ₂ O with purge valve open) indicates blockage	Dirty frit	Exchange the purge valve frit or the purge valve
Leaks at lower pump head side	High seal wear	Run leak test for verification and exchange the pump seals
Unstable retention time		
Pressure ripple unstable		
Seal lifetime shorter than normally expected	Scratch on plunger	Check plungers while changing the seals
Loss of wash solvent	Leaky wash seals	Exchange the wash seals

Pump Kits

Description	Kit Contents	Part No.
Starter Kits		
Pump start-up kit (400 bar)	Includes outlet cap, PTFE frits (5/pk), piston seals (4/pk), outlet gold seal, 20 µm glass solvent inlet filters (2/pk), cartridge for active inlet valve	G1311-68710
Preventive Maintenance Kits		
Extended preventive maintenance kit, for 1100/1050/1200 pumps	Includes piston seals (2/pk), PTFE frits (5/pk), cartridge active inlet valve, outlet ball valve, pistons (2/pk)	5065-4499
Preventive maintenance kit, for 1100/1200/1120 isocratic or quaternary pumps (400 bar)	Includes piston seals (2/pk), PTFE frits (5/pk), seal caps (2/pk)	G1310-68730
Preventive maintenance kit, for 1260 Infinity LC isocratic or quaternary and 1220 pumps (600 bar)	Includes PTFE pump seals (2/pk), PTFE frits (5/pk), seal caps (2/pk), film washers (2/pk)	G1310-68741
Preventive maintenance kit, for bio-inert quaternary pump (600 bar)	Includes bio-inert piston seal, PTFE frits (5/pk), seal cap assembly, film washer, peristaltic pump, silicone tubing, bio-inert wash seal	G5611-68741



Seal cap, 5067-4728

(Continued)



Pump start-up kit, G1311-68710



Piston seals, 5063-6589



PTFE frits, 01018-22707

Pump Kits

Description	Kit Contents	Part No.
Preventive maintenance kit, for 1100/1200 binary pump (400 bar)	Includes PTFE pump seals (4/pk), seal caps (3/pk), PTFE frits (5/pk), film washers (4/pk)	G1312-68730
Preventive maintenance kit, for 1260 Infinity LC binary pump (600 bar)	Includes PTFE pump seals (4/pk), seal caps (3/pk), PTFE frits (5/pk), film washers (4/pk)	G1312-68741
Preventive maintenance kit, for 1100/1200 and 1260 Infinity LC preparative pump	Includes filter cup, seal prep flange (4/pk), filter assembly, peristaltic pump	G1361-68710
Preventive maintenance kit, for G1376A capillary pump	Includes pump seals (4/pk), stainless steel frit, seal cap assembly (4/pk)	G1376-68710
Preventive maintenance kit, for 1290 Infinity binary pumps*	Includes polyethylene pump seals (4/pk), PTFE frits (5/pk), seal cap assembly (4/pk)	G4220-68741
Seal wash preventive maintenance kit, for 1290 Infinity binary pumps*	Includes polyethylene wash seals (4/pk), film washers (4/pk), peristaltic pump	G4220-68742
Preventive maintenance kit, for 1290 Infinity quaternary pumps*	Includes polyethylene pump seals (2/pk), frit assembly, seal cap assembly, frit for inline filter, 0.3 µm (5/pk)	G4204-68741
Seal wash preventive maintenance kit, for 1290 Infinity quaternary pumps*	Includes polyethylene wash seals (2/pk), film washers (2/pk), peristaltic pump	G4204-68742
Preventive maintenance kit, for 1260 Infinity II flexible pump and 1290 Infinity II flexible pump with Long Life or Easy Maintenance pump heads	Including polyethylene pump seals (2/pk), wash seals (2/pk), peristaltic pump, inline filter frit (5/pk), frit assembly for outlet filter	G7104-68741
Preventive maintenance kit, for 1290 Infinity II binary pumps with Long Life and Easy Maintenance pump heads	Includes polyethylene pump seals (4/pk), wash seals (4/pk), seal cap assembly (2/pk), frit assembly, PTFE frits	G7120-68741

(Continued)

Pump Kits

Description	Kit Contents	Part No.
Instrument Tool Kits		
1290 Infinity II LC tool kit	Includes hex key set, seal insert tool, hex driver slitted (3/pk), wrenches, plastic syringe, syringe adapter, blanking nut	G7120-68708
Compact tool kit	Includes tool for 1/8 nut, seal insert tool, wrench 0.25 inch to 0.31 inch, open wrench 14 mm, hex key (2.5 mm, 4 mm), 9/64 inch, wrench 0.50 inch to 0.56 inch	G4296-68715
1290 Infinity pump service kit	Includes pump seal exchange tool, torque wrench, hex bit (2.5 mm, 4 mm), 19 mm open wrench, torx bit 10 x 25 mm, adapter 0.25 inch square to hex	5067-4699
1290 Infinity pump service kit, for pumps with Long Life and Easy Maintenance pump heads	Includes torque wrench, torx bit 10 x 25 mm, adapter 0.25 inch square to hex, pump head holder, seal handling device, wrench 0.25 inch to 0.31 inch, abrasive paper	5067-6652
Active seal wash kit	Includes 2 wash seal gaskets, 2 pump seals, peristaltic pump (includes pump cassette and motor), 2 seal keepers, 2 support ring assemblies, seal insert tool, silicone tubing	G1311-68711



Compact tool kit, G4296-68715

*Tool kit 5067-4699 required for servicing 1290 Infinity pump heads (except pumps equipped with Long Life or Easy Maintenance pump heads)

TIPS & TOOLS

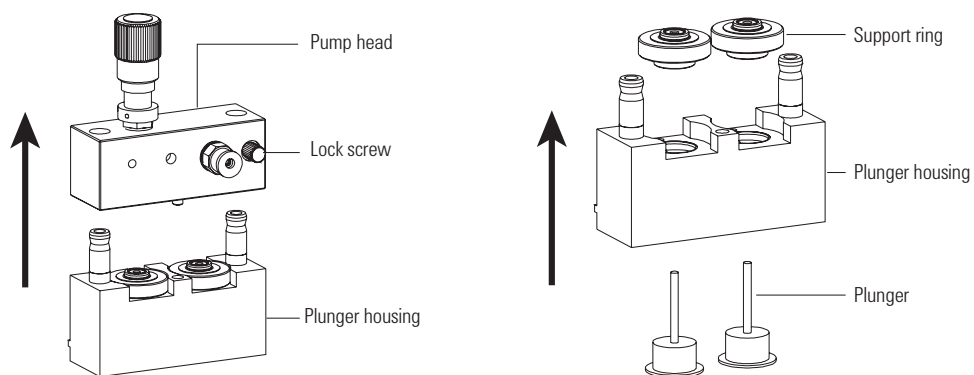

Information on maintenance procedures can be found at www.agilent.com/chem/LCmaintenancenotes

Autosampler Kits



Autosampler Maintenance Schedule

Procedure	When to Perform	Time Required
Exchanging the needle assembly	When needle shows indication of damage or blockage	15 minutes
Exchanging the seat assembly	When the seat shows indication of damage or blockage	10 minutes
Exchanging the metering seal	When autosampler reproducibility indicates seal wear	30 minutes



Start-up kit, for G1313A, G1329A samplers,
G1313-68709

Autosampler Kits

Description	Kit Contents	Part No.
Starter Kits		
Start-up kit for G1313A, G1329A autosamplers	Includes Vespel rotor seal, needle seat, needle, metering seals (2/pk) and finger caps (15/pk)	G1313-68709
Preventive Maintenance Kits		
For G1313A, G1329A samplers	Includes Vespel rotor seal, needle seat, needle	G1313-68730
Extended kit for G1313A, G1329A autosamplers	Includes Vespel rotor seal, needle seat, needle, isolation seal, stator face	5065-4498
For G1329B autosampler	Includes PEEK rotor seal, needle, seat assembly, seal for metering piston	G1313-68719
For G1367A/B autosamplers	Includes needle assembly, needle seat, peristaltic pump, Vespel rotor seal, seal-tight nut (loop fitting)	G1367-68730
For G1367C/D sampler	Includes needle assembly, needle seat, peristaltic pump, PEEK rotor seal, seal-tight nut (loop fitting)	G1367-68734
For G1367E autosampler	Includes needle assembly, needle seat, peristaltic pump, PEEK rotor seal	G1367-68741

(Continued)

Autosampler Kits

Description	Kit Contents	Part No.
For G4277A/ G4278A/G4270- CTC/G4271-CTC (all PAL) samplers	Includes tension cord for injection unit, needle seal and lubrication kit	G6500-88088
For G4226A sampler	Includes needle assembly, needle seat, peristaltic pump, Vespel rotor seal	G4226-68735
For G7129A vialsampler	Includes needle assembly, needle seat assembly, PEEK rotor seal, finger caps (15/pk)	G7129-68740
For G7129B vialsampler	Includes needle assembly, needle seat assembly, Vespel rotor seal, finger caps (15/pk)	G7129-68730
For G7167B multisampler standard	Includes needle assembly, high pressure needle seat, PEEK rotor seal	G7167-68710
For G7167B multisampler dual needle	Includes needle assembly (2/pk), high pressure needle seat (2/pk), PEEK rotor seal, rotor seal injection valve	G7167-68720
For G7167A multisampler standard	Includes needle assembly, high pressure needle seat, PEEK rotor seal	G7167-68730
For G5668A bio- inert multisampler	Includes needle assembly, high pressure needle seat, PEEK rotor seal	G5668-68730



1260 Infinity multisampler with multiwash open,
G7167A

Detector Maintenance Kits



Detector Maintenance Tips



Symptom	What To Do	Additional Information
Lamp does not ignite	Exchange the lamp	Perform a wavelength calibration test and an intensity test after lamp replacement
Noise exceeds application limit	Check lamp and flow cell. Maintain or exchange the flow cell. Replace lamp.	Perform a wavelength calibration test after replacement
Drift exceeds application limit	Exchange the lamp	Perform a wavelength calibration test and an intensity test after lamp replacement
Leaky flow cell (For G4212/G7117)	Exchange the flow cell	Perform a wavelength calibration test after flow cell replacement
Leaky flow cell (For G1314/G1315/G1365/ G7114/G7115/G7165)	Clean, replace parts or exchange the flow cell	Perform a wavelength calibration test after flow cell replacement
Lower intensity (For G4212/G7117)	Flush or exchange the flow cell	Perform a wavelength calibration test after flow cell replacement
Lower intensity (For G1314/G1315/G1365/ G7114/G7115/G7165)	Clean, replace parts or exchange the flow cell	Perform a wavelength calibration test after flow cell replacement

Detector Maintenance Kits



Description	Kit Contents	Part No.
Variable Wavelength Detector (VWD)		
High-pressure flow cell kit	Includes windows (2/pk), Kapton gaskets (2/pk), PEEK rings (2/pk)	G1314-65054
Micro flow cell kit	Includes windows (2/pk), gaskets #1 (2/pk), gaskets #2 (2/pk)	G1314-65052
Semimicro flow cell kit	Includes windows (2/pk), gaskets: standard #1 (2/pk), semi-micro #1, semi-micro #2	G1314-65056
Standard flow cell kit (flow cell G1314-60080)	Includes windows (2/pk), gaskets #1 (2/pk), gaskets #2 (2/pk)	G1314-65050
Standard flow cell kit (flow cells G1314-60086, G1314-60186)	Includes windows (2/pk), gaskets #1 (2/pk), gaskets #2 (2/pk)	G1314-65061
Cell screw kit	Includes window holders assembled with windows and washers (2/pk)	79883-68703
Cell screws		G1314-65062

(Continued)

Detector Maintenance Kits

Description	Kit Contents	Part No.
Diode Array Detector (DAD)/Multiple Wavelength Detector (MWD)		
Inline pressure relief valve kit, for G4220A, G4220B	Includes pressure relief valve, fittings, tubing, and instructions.	G4212-68001
Cell repair kit, for standard cell For G1315A/B, G1365A/B, G1315C/D, G1365C/D, G7115A	Includes window screw kit, 4 mm hexagonal wrench, seal kit	G1315-68712
Cell repair kit, semimicro cell For G1315A/B, G1365A/B, G1315C/D, G1365C/D, G7115A	Includes window screw kit, 4 mm hexagonal wrench, seal kits	G1315-68713
High-pressure cell repair kit For G1315A/B, G1365A/B, G1315C/D, G1365C/D, G7115A	Includes quartz window, spring washers (5/pk), seal rings (2/pk)	79883-68700
Sealing kit, for 500 nL flow cell	Includes torque adapter, cell seal assembly (2/pk), LiteTouch front and back ferrules (5/pk)	G1315-68715
Sealing kit, for 80 nL flow cell	Includes torque adapter, cell seal assembly (2/pk), LiteTouch front and back ferrules (5/pk), sleeves for 360 µm od capillaries (5/pk)	G1315-68725
Standard cell repair kit, 1050/1090	Includes gaskets (12/pk), window holders assembled with windows and washers (2/pk), cell screws (2/pk), washers (10/pk), hex key	79883-68701



Legacy System Kits

Stay-Fit Kits for 1100 Series Systems

Description	Kit Contents	Part No.
1100 Quat/ALS Stay-Fit maintenance pack	Piston seals (2/pk), PTFE frits (5/pk), seal caps (2/pk), rotor seal (Vespel), ALS needle, ALS seat capillary, glass filter solvent inlet (4/pk), frit adapter solvent inlet (4/pk)	01100-68000
1100 Quat/ALS/VWD Stay-Fit maintenance pack	Piston seals (2/pk), PTFE frits (5/pk), seal caps (2/pk), rotor seal (Vespel), ALS needle, ALS seat capillary, glass filter solvent inlet (4/pk), frit adapter solvent inlet (4/pk), D2 Lamp	01100-68001
1100 Bin/ALS Stay-Fit maintenance pack	Piston seals (4/pk), PTFE frits (5/pk), seal caps (3/pk), rotor seal (Vespel), sieves for outlet valve, ALS needle, ALS seat capillary, glass filter solvent inlet (4/pk), frit adapter solvent inlet (4/pk)	01100-68002
1100 Bin/ALS/DAD Stay-Fit maintenance pack	Piston seals (4/pk), PTFE frits (5/pk), seal caps (3/pk), sieves for outlet valve, rotor seal (Vespel), ALS needle, ALS seat capillary, glass filter solvent inlet (4/pk), frit adapter solvent inlet (4/pk), long-life deuterium lamp	01100-68003
1100 Quat/WPS Stay-Fit maintenance pack	Piston seals (2/pk), PTFE frits (5/pk), seal caps (2/pk), rotor seal (Vespel), WPS needle, WPS seat capillary, peristaltic pump, nut seal tight fitting for loop capillary, glass filter solvent inlet (4/pk), frit adapter solvent inlet (4/pk)	01100-68004
1100 Quat/WPS/VWD Stay-Fit maintenance pack	Piston seals (2/pk), PTFE frits (5/pk), seal caps (2/pk), rotor seal (Vespel), WPS needle, WPS seat capillary, peristaltic pump, nut seal tight fitting for loop capillary, glass filter solvent inlet (4/pk), frit adapter solvent inlet (4/pk), D2 lamp	01100-68005
1100 Bin/WPS Stay-Fit maintenance pack	Piston seals (4/pk), PTFE frits (5/pk), seal caps (3/pk), sieves for outlet valve, rotor seal (Vespel), WPS needle, WPS seat capillary, peristaltic pump, nut seal tight fitting for loop capillary, glass filter solvent inlet (4/pk), frit adapter solvent inlet (4/pk), D2 lamp	01100-68006
1100 Bin/WPS/DAD Stay-Fit maintenance pack	Piston seals (4/pk), PTFE frits (5/pk), seal caps (3/pk), sieves for outlet valve, rotor seal (Vespel), WPS needle, WPS seat capillary, peristaltic pump, nut seal tight fitting for loop capillary, glass filter solvent inlet (4/pk), frit adapter solvent inlet (4/pk), long-life deuterium lamp	01100-68007

Preventive Maintenance Kits for 1120/1220 Series Systems

Description	Kit Contents	Part No.
Preventive maintenance kit, for 1220 Infinity LC, automated injector systems	Includes piston seals (2/pk), PTFE frits (5/pk), Vespel rotor seal, needle, needle seat, seal cap assembly (2/pk)	G4280-68730
Preventive maintenance kit, for 1120 manual injector systems	Includes piston seals (2/pk), PTFE frits (5/pk), PEEK rotor seal, seal cap assembly (2/pk)	G4280-68710
Preventive maintenance kit, for 1220 automated injector systems	Includes piston seals (2/pk), PTFE frits, rotor seal, seal cap assembly (2/pk), needle, and needle seat	G4280-68770
Preventive maintenance kit, for 1220 manual injector systems	Includes piston seals (2/pk), PTFE frits, rotor seal, seal cap assembly (2/pk)	G4280-68750

PUMP SUPPLIES

Agilent pumps feature superior stability and composition precision. LC pumps include isocratic, binary, quaternary, capillary, and preparative; all key components can be accessed by simply removing the front cover.

Agilent quality parts are designed, tested, and manufactured with the same attention to detail you expect from Agilent instruments.

That means your LC or LC/MS system will deliver superior qualitative and quantitative results and consistent reproducibility and reliability.

Purge Valves

PTFE frits

The PTFE frit is a crucial part in the flow path that prevents particulates and microbes from getting into the system. It is important that frits maintain their shape up to the pressure limit of the system, since collapse or abrasion of the frit can release PTFE particles, resulting in blockage or loss of analysis efficiency.

Scanning electron microscopy (SEM) inspection reveals that sizes of PTFE particles in Agilent frits are much more uniform than frits from other vendors. If the frit is abraded, particles that are too large can block the flow path, while particles too small can pass through the column inlet frit, getting into the column, or even reach the detector causing contamination of the flow cell. In contrast to alternative frits, Agilent frits are designed to have a defined particle size to avoid these issues.

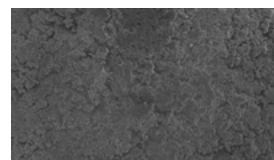

Agilent

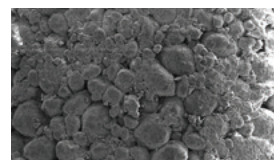

Other vendor

Scanning electron microscope (SEM) image showing the superior uniformity of Agilent frits



Purge valve long with PTFE frit (600 bar),
G1312-60071



Purge valve short with PTFE frit (600 bar),
G7111-60061



PTFE frits, 01018-22707

Purge Valves

Description	Comments	Part No.
Manual Purge Valves		
Purge valve, long, with PTFE Frit, 600 bar	For pumps G1310A/B, G1311A/B/C, G1312A/B/C, G1376A, G2226A, G7111A/B, G7112B, G4302A, G4782A	G1312-60071
Purge valve, short, with PTFE Frit, 600 bar	For 1120/1220 Series pumps	G7111-60061
Bio-inert purge valve, long	1260 Infinity Bio-inert quaternary pump (G5611A)	G5611-60062
Bio-inert purge valve, short	1260 Infinity II Bio-inert quaternary pump (G5654A)	G5611-60064
PTFE frits, 5/pk	For 1290 Infinity binary pumps (G4220A/B) and all 1260 Infinity/1200 Series/1100 Series and analytical pumps	01018-22707
Seal cap	For all manual purge valves	5067-4728
Automated Purge Valves		
Rotor seal (Vespel), 1200 bar	For G4220A/B	5068-0005
Stator head, 1200 bar/1300 bar	For G4220A/B, G7120A	5068-0004
Purge valve head, 1300 bar	For G7120A	5067-4236
Rotor seal (PEEK), 1300 bar	For G7120A	5068-0201
Rotor, for multipurpose valve head, 1200 bar	For G4204A	5068-0123
Stator, for multipurpose valve, 1200 bar / 1300 bar	For G4204A, G7104A/C	5068-0001
Rotor, for multipurpose valve head, 1300 bar	For G7104A	5068-0202
Rotor, for 8 position/9 port purge valve, 800 bar	For G7104C	5068-0299

TIPS & TOOLS

Information on maintenance procedures can be found at
www.agilent.com/chem/LCmaintenancenotes

Inlet and Outlet Valves

Inlet Valves

Description	Comments	Part No.
Active Inlet Valves		
Seal cap	For all manual purge valves	5067-4728
Active inlet valve, without cartridge	For G1310A, G1311A/B/C, G1312A/B/C, G7111A/B, G1376A, G2226A	G1312-60025
Cartridge, for active inlet valve, 400 bar	For G1310A, G1311A/C, G1312A/C, G1376A, G2226A	5062-8562
Cartridge, for active inlet valve, 600 bar	For G1310B, G1311B, G1312B, G7111A/B, G7112B	G1312-60020
Bio-inert active inlet valve	For G5611A, G5654A	G5611-60025
Bio-inert cartridge, for active inlet valve, 600 bar	For G5611A, G5654A	G5611-60020
Passive Inlet Valves		
Passive inlet valve, 600 bar	For G1310B, G1311B, G1311C, G7111A/B, G7112B, 1120/1220, G4302/G4782A (channel B)	G1312-60066*
Passive inlet valve, 800/1200/1300 bar	For G4204A, G7104A/C	G4204-60022*
Passive inlet valve, 1200/1300 bar	For G4220A/B, G7120A	G4220-60022*
1260 Infinity LC inlet valve, type N	For normal phase applications. Used with G1310A, G1311A/B/C, G1312A/B/C, G7111A/B, G7112B, G1376A, G2226A	G1312-60166*
Passive inlet valve, Type N, 1300 bar	For normal phase applications. Used with 1290 Infinity binary pumps and 1290 Infinity II high speed pumps	G4220-60122*
Passive inlet valve replacement kit	For 1120/1220	G4280-60500*
Inlet valve for SFC pump	For G4302A, G4782A (channel A)	G4302-60066*
Valve assemblies (inlet/outlet), for preparative pumps	For G1361A	G1361-60012

*Inlet valve with integrated seal



Seal cap, 5067-4728



Cartridge, 400 bar, 5062-8562



AIV cartridge, 600 bar, G1312-60020



Passive inlet valve, G1312-60066



Outlet valve, G1312-60067



Outlet valve, G4220-60028



Valve assemblies, G1361-60012

Outlet Valves

Description	Comments	Part No.
Outlet valve, 600 bar	For G1310A/B, G1311A/B/C, G1312A/B/C, G1376A, G2226A, G7111A/B, G7112B, 1120/1220, G4302/G4782A (channel B)	G1312-60067*
Outlet valve, Type N, 600 bar	For normal phase applications. Used with G1310A, G1311A/B/C, G1312A/B/C, G7111A/B, G7112B, G1376A, G2226A, G4302/G4782A (channel A)	G1312-60167*
Outlet valve 1200/1300 bar	For G4204A, G4220A/B, G7104A/C, G7120A	G4220-60028*
Outlet valve, type N, 1300 bar	For normal phase applications. Used with G4204A, G4220A/B, G7104A/C, G7120A	G4220-60128*
Internal gold seal, for 1290 outlet valve	Internal gold seal for G4220-60028, G4220-60128	G4220-20020
Bio-inert outlet valve, 600 bar	For G5611A, G5654A	G5611-60067*
Stainless steel sieve	For G1312-60012 valve (valve replaced by G1312-60067)	5063-6505
Valve assemblies (inlet/outlet), for prep pumps	For G1361A	G1361-60012

*Outlet valve with integrated seal

Enhance traceability and simplify documentation

InfinityLab Poroshell 120 columns with Column ID make it easy to document columns and conditions for routine analysis.

Benefits include:

- **Usability**—find column details easily
- **Traceability**—know exactly which column is/was installed
- **Security**—avoid running methods incompatible with the column

Turn to **Page 128** to find out more.



Pistons and Piston Seals

Agilent pistons are made from a high purity, monocrystalline sapphire for maximum durability.

Agilent sapphire pistons are:

- Meticulously cut at just the right angle, making them durable — and long lasting
- Precisely aligned in their stainless steel holder to minimize wear on the piston and seal

Agilent seals are designed to fit snugly around our pistons, and are capable of adapting to a wide range of flow rates and pressures.

Agilent piston seals are:

- Spring-loaded and engineered to deliver optimal performance over highly dynamic flow and pressure ranges
- Manufactured from a proprietary polymer blend, and feature a spring made from the same high-quality stainless steel that is used in our pump's flow path

The combination of our piston and seal has undergone extensive testing under temperature stress, with all common HPLC solvents, and in many instruments. More importantly, they yield consistent, reproducible results.

Pistons

Description	Comments	Part No.
Sapphire piston (standard base size)	For G1310A/B/C, G1311A/B/C, G1312A/B/C, G7112B, G1376A, G2226A, 1120/1220	5063-6586
Wash pump piston assembly	For G4309A	G4301-60130
Ceramic piston	For G4204A, G4220A/B	5067-5678
Ceramic piston (Easy Maintenance pump head)	For G4204A, G4220A/B if equipped with Easy Maintenance pump heads	5067-5938
Ceramic piston (Long Life pump head)	Standard for G7104A/C, G7120A For G4204A, G4220A/B if equipped with Long Life pump heads	5067-5975
Sapphire piston (preparative)	For G1361A	G1361-22402
Sapphire piston (slim base)	For G5611A, G4302A, G4782, G4226A, G1376A	5067-4695
Piston SFC booster	For G4301A	G4301-20201



Ceramic piston (Long Life pump head), 5067-5975



Sapphire piston (preparative), G1361-22402



Piston seals (reversed phase), 5063-6589

Piston Seals

Description	Comments	Part No.
Piston seal, PTFE, 2/pk (reversed-phase)	For G1310A/B/C, G1311A/B/C, G1312A/B/C, G7112B, G1376A, G2226A, 1120/1220	5063-6589
Piston seal, PE, 2/pk (normal phase)	For G1310A/B/C, G1311A/B/C, G1312A/B/C, G7112B, G1376A, G2226A, 1120/1220	0905-1420
Bio-inert piston seal	For G5611A, G5654A	G5611-21503
Pump seal, PE, for 1290 Infinity LC (normal and reversed-phase)	For G4204A, G4220A/B, G7104A/C, G7120A	0905-1719
Seal prep flange	For G1361A	5022-2188
O-ring	For G1361A	0905-1516

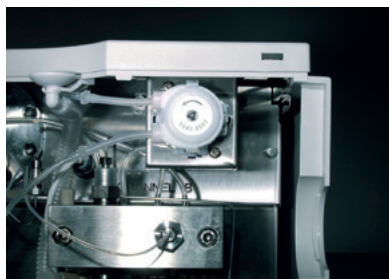

Seal Wash

The routine use of highly concentrated buffer solutions (100 mM) will reduce the life of seals and pistons in your pump. Counteract the problem with one of Agilent's seal wash kits, which flush the back of the seal with a wash solvent.

Note: Water/isopropanol (90:10 v/v) is recommended as the wash solvent.

Seal Wash

Description	Comments	Part No.
Seal Wash Pumps		
Peristaltic pump, with PharMed tubing, includes spring coils and tube adapters	Standard for 1100/1200/1200 RRLC, Infinity and Infinity II LC pumps, and autosamplers with needle wash	5065-4445
Peristaltic pump, with silicone tubing	For 1100/1200/1200 RRLC, Infinity and Infinity II LC pumps	5042-8507
Peristaltic pump, with ChemSure tubing	For 1100/1200/1200 RRLC, Infinity and Infinity II LC pumps	5065-9952

(Continued)



Peristaltic pump, 5042-8507



Peristaltic pump with ChemSure tubing, 5065-9952

Seal Wash

Description	Comments	Part No.
ChemSure tubing	Replacement tube for 5065-9952	5042-8954

Wash Seals

Wash seal, PTFE (reversed-phase)	For 1260 Infinity and Infinity II pumps, 1290 Infinity and Infinity II pumps (with Easy Maintenance or Long Life pump heads only), 1100/1200 pumps	0905-1175
Wash seal, polyethylene, for 1290 Infinity LC	For 1260 Infinity and Infinity II pumps, 1290 Infinity and Infinity II pumps (with classical pump heads only), 1100/1200 series pumps (optional for normal phase applications)	0905-1718
Wash seal, bio-inert	For G5611A, G5654A	0905-1731

Various Parts and Kits

Seal keeper	For G1310A, G1311A/C, G1312A/C, 1120	5001-3743
Seal keeper, bio-inert	For G5611A, G5654A	G5611-26210
Seal holder, ceramic	For G1312B, G1311B/C, G7111A/B, G7112B, 1220	5042-8952
Seal wash gasket, 6/pk	For G1310B, G1311B/C, G1312B/C, G7111A/B, G7112B, G7104A/C, G7120A, 1120/1220, G4782A	5062-2484
Support ring seal wash	For G1310A, G1311A/B/C, G1312A/B/C, G7111A/B, G7112B	01018-60027
Support ring, for 1290 Infinity LC with seal wash	For G4204A, G4220A/B, G4782A	G4220-63010
Silicone tubing, 1 mm id, 3 mm od, 5 m	Tubing for inter pump-head and waste connections	5065-9978
Active seal wash kit	For 1100/1200 isocratic or quaternary pumps	G1311-68711
Active seal wash kit	For G1312A/B/C	G1312-68711
Bio-inert wash seal	For G5611A, G5654A	0905-1731
Continuous seal wash kit	For 1100/1200/1200 RRLC pumps	01018-68722
Wash pump seal kit	For 1260 Infinity SFC	G4301-60140

TIPS & TOOLS

Information on maintenance procedures can be found at www.agilent.com/chem/LCmaintenancenotes



Solvent mixer, 5067-1565



Infinity LC inline filter, 5067-6189



InfinityLab solvent cabinet, with solvent bottles and Stay Safe caps

Filters and Mixers

Description	Comments	Part No.
Solvent mixer, 1100 Series	For G1312A/B/C, G7112B	G1312-87330
Solvent mixer, short, 200 μ L	For G1312A/B/C, G7112B	5067-1565
Jet weaver, 35 μ L/100 μ L, for binary pumps	For G4220A, G4220B	G4220-60006
Jet weaver, 380 μ L, for binary pumps	For G4220A, G4220B	G4220-60012
Jet weaver mixer kit, 35 μ L, for quaternary and flexible pumps	For G4204A, G7104A, G7104C Includes connection capillaries	G4204-68035
Jet weaver mixer kit, 100 μ L, for quaternary and flexible pumps	For G4204A, G7104A, G7104C Includes connection capillaries	G4204-68100
Jet weaver mixer kit, 380 μ L, for quaternary and flexible pumps	For G4204A, G7104A, G7104C Includes connection capillaries	G4204-68380
Combo mixer assembly	For G7120A	G4220-60027
Inline filter, 0.3 μ m, for 1290 Infinity II LC systems	Inline filter, with replaceable filter frits, comes with stainless steel cartridge, flexible capillary, and rigid connection capillary	5067-6189
Filter frits, 0.3 μ m, 5/pk	Replacement filter frits, for 5067-6189	5023-0271
Stainless steel filter assembly, with PEEK ring, 2 μ m pore size	For G1361A	5022-2192

Agilent Captiva Premium Syringe Filters

Protect your samples and your results

Even small amounts of particulate can clog your column inlet, causing high column backpressure, retention-time shift, resolution loss, and shorter column life. Agilent Captiva Premium Syringe Filters—developed by chromatographers—remove damaging particulates for optimal performance, column lifetime, and sample integrity.

To order, visit www.chem.agilent.com/store



Supplies for the SFC Control Module (G4301A)

Description	Comments	Part No.
Seal, SFC booster pump	For 1260 Infinity II SFC control module	G4301-20200
Wash pump seal kit	For 1260 Infinity and 1260 Infinity II SFC control module	G4301-60140
Wash pump piston assembly	For 1260 Infinity and 1260 Infinity II SFC control module	G4301-60130
Low dispersion nozzle assembly	For 1260 Infinity II SFC control module	G4301-67501
Capillary, SFC booster pump, out, rigid stainless steel	For 1260 Infinity II SFC control module	G4301-60056
Booster pump seals, 2/pk	For 1260 Infinity SFC control module	G4301-60250

Solvent Reservoir and General Supplies**Safer laboratory solvent bottles**

Agilent's solvent bottles have been designed for easier use and safer handling, lowering the risk of accidents in the lab.

These solvent bottles feature:

- An ergonomic design, the slimmer profile and ergonomically shaped gripping zones on both sides of the bottle promote easier and safer use
- A predefined labeling area with self-adhesive labels and colorful silicone bottle tags, mean that you can clearly and unambiguously identify solvent compositions
- An easy to read durable white ceramic print layout clearly indicates the nominal volume of the bottle and allows you to quickly determine the rest contents of the bottle

These solvent bottles are compatible with any LC instrument, and can be incorporated seamlessly into your LC workflow.

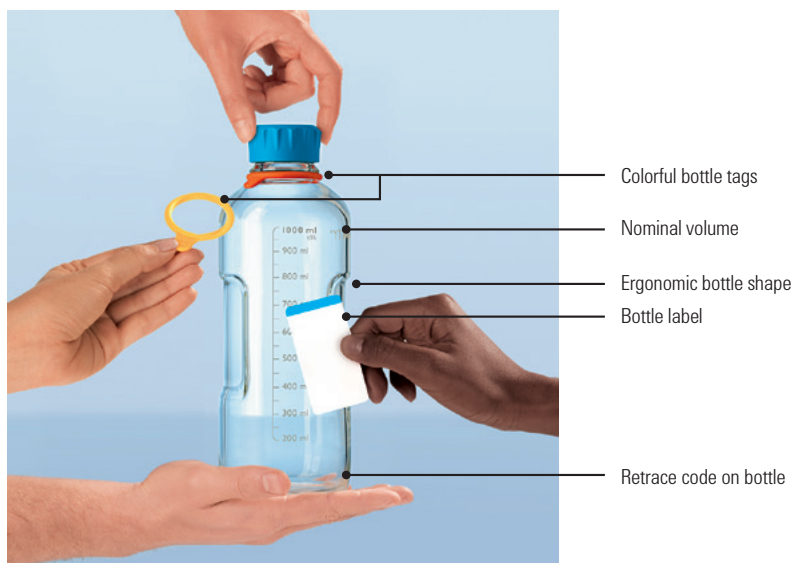

1260 Infinity II SFC control module





InfinityLab solvent bottle, clear, 1 L, 9301-6528



InfinityLab solvent bottle, amber, 1 L, 9301-6526

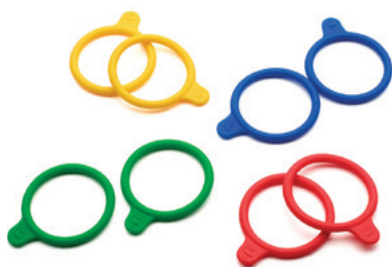

InfinityLab identification silicone rings, 8/pk, 9301-6529

Solvent Reservoir and General Supplies

Description	Comments	Part No.
Standard bottle cap, with 3-hole insert		5063-6531
InfinityLab solvent bottle, clear, 1 L	93 mm diameter, 253 mm height, GL45 thread	9301-6524
InfinityLab solvent bottle, clear, 1 L, with cap	93 mm diameter, 253 mm height, GL45 thread	9301-6528
InfinityLab solvent bottle, amber, 1 L	93 mm diameter, 253 mm height, GL45 thread	9301-6526
InfinityLab solvent bottle, clear, 500 mL, with cap	78 mm diameter, 195 mm height, GL45 thread	9301-6523
InfinityLab solvent bottle, amber, 500 mL, with cap	78 mm diameter, 195 mm height, GL45 thread	9301-6525
InfinityLab solvent bottle, clear, 125 mL, with cap	GL45 thread	9301-6527
Solvent bottle, clear, 2 L, 2 inlets	GL45 thread	5065-4421
Solvent bottle, amber, 2 L	GL45 thread	9301-6341
Solvent bottle, clear, 2 L	GL45 thread	9301-6342
InfinityLab identification silicone rings, 8/pk	Four colors	9301-6529
Sticker, for solvent bottles, 100/pk	Removable	9301-6530
Bottle head tubing, ultra clean quality (recommended for MS application)	Includes set of clips for marking the various channels, and solvent tubes, 2280 mm long, with premounted fittings on one side (1/4-28), 4/pk	5043-1789
Bottle head tubing	Includes set of clips for marking the various channels, and solvent tubes, 2280 mm long, with premounted fittings on one side (1/4-28), 4/pk	5043-1790
Bottle Head Assembly		
Bottle head assembly, for screw bottle	For 1100/1200/1260 series systems	G1311-60003
Bottle head assembly	For 1260 Infinity II, 1290 Infinity/Infinity II LC	G7120-60007
Bottle head assembly, extra long (2280 mm)		G7122-60007
Bottle head assembly, ultra clean tubing quality	Recommended for MS applications, 1290 Infinity/Infinity II LC	G7120-60017
Tubing kit, ultra clean quality	Recommended for MS applications, includes bottle head assemblies (G7120-60017, 4/pk), and tubing kits, 140 mm (G4220-60070, 3/pk)	G7120-68070
Tubing kit, 140 mm, 2/pk	SSV to shutoff valve or degassing unit (binary pump), degasser to MCGV (quaternary pump)	G4220-60035
Tubing kit, 140 mm, 2/pk, ultra clean tubing quality	Recommended for MS applications	G4220-60070
Bottle head assembly, for prep system	4.7 mm od tubing	G1361-60022

Solvent Filters

Solvent inlet filters represent the first barrier for retaining particulates, precipitation, microbes from mobile phases, buffers, and salt solutions. Filters are significant in preventing system blockage, pressure increase, and contamination. Cleanliness of parts is vital for avoiding system contamination. Agilent solvent filters are packed in ultraclean antistatic bags with an inner metallic coating that does not release contaminants such as plasticizers or antioxidants. LC/MS analysis shows that filters not from Agilent, packed in normal plastic packs, can cause extra peaks during analysis. Erucamide, a common slip agent used in polyethylene films, is one such example.

Pore size

A good solvent glass filter should have a defined, homogenous pore size to effectively block particulates above a certain size, while letting mobile phases through without significant pressure increase. Too large pore size leads to deficiency of filtration, while pores that are too small can cause pressure increase, resulting in solvent pumping difficulties. Inspection of Agilent and other vendor solvent glass filters by scanning electron microscopy (SEM) shows uniform pore sizes and smooth particle surfaces in the Agilent filter. In contrast, other vendor filters had inconsistent particle and pore sizes. The small particles or particle fragments shown on the other vendor filter could be flushed into the flow path, blocking the pump frit, capillaries, valves, or columns.



Glass filter, solvent inlet, 20 µm pore size, 5041-2168



Stainless steel filter, solvent inlet, 10 µm pore size, 01018-60025



Filter frit adapters, 5062-8517

Solvent Filters

Description	Recommended Use	Part No.	Frit Adapter	Part No.	Frit Inlet id (mm)	Tube od (mm)
Glass filter, solvent inlet, 20 µm pore size	Analytical scale, micro scale	5041-2168	Frit adapter, PTFE, 3 mm, 4/pk	5062-8517	5	3.2
Stainless steel filter, solvent inlet, 10 µm pore size	For use in capillary and nano systems	01018-60025	No adapter required, filter goes directly into 1.5 mm id tubing			
Glass filter, solvent inlet, 40 µm pore size	Preparative LC	3150-0944	Frit adapter, PTFE, for 4.7 mm od tubing	G1361-23205	7	4.7
Glass filter, solvent inlet, 40 µm pore size	Preparative LC	3150-0944	Frit adapter, PTFE, 4 mm	G1361-23204	7	4
Glass filter, solvent inlet, 40 µm pore size	For G2258A dual loop autosampler	3150-0944	Frit adapter, PTFE, for 3.2 mm od tubing	G2258-23201	7	3.2

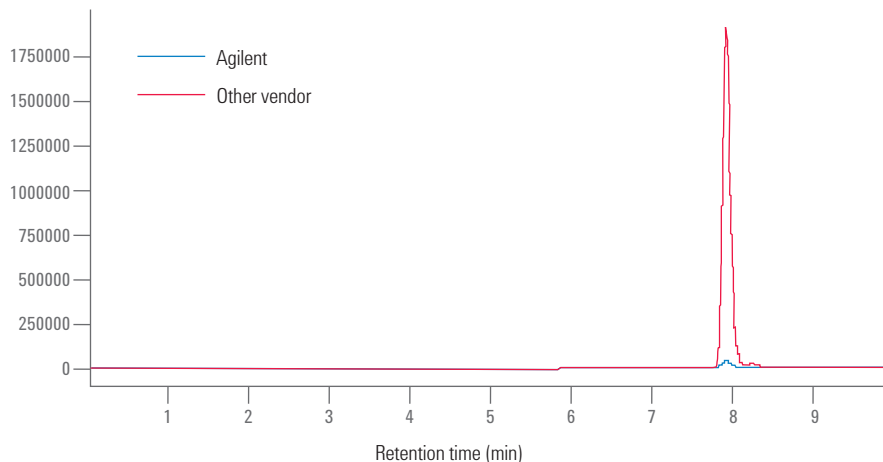

Non-Agilent filters packed in normal plastic packs can cause extra peaks during analysis

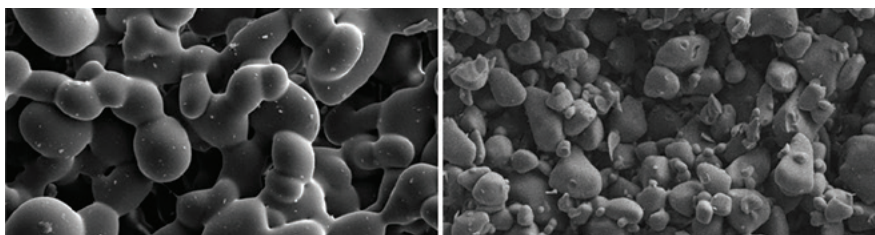

Agilent

Other vendor

Scanning electron microscope (SEM) image of solvent inlet glass filter from Agilent and another vendor, showing the superior pore-size homogeneity of the Agilent product.



CLEANING THE SOLVENT FILTER

If the filter is in good condition, the solvent will freely drip out of the solvent tube (hydrostatic pressure). If the solvent filter is partially blocked, only very little solvent will drip out of the solvent tube.

Caution: Small particles can permanently block the capillaries and valves of the module.

- Always filter solvents
- Never use the module without solvent inlet filter

InfinityLab Stay Safe Caps

Open or partially covered solvent bottles can lead to the evaporation of solvents and harmful solvent vapors. Agilent InfinityLab Stay Safe caps stop solvents from leaching into the air.

Over time, solvent composition can change, affecting your chromatographic results. Storing solvents with airtight Stay Safe caps prevents this problem, ensuring the long-term consistency of your mobile phase for more reproducible results.

Stay Safe caps include an easy-to-see time strip (time based indicator) that tells you when the venting valve and charcoal filter needs to be replaced. We recommend changing the venting valve and charcoal filter after six months of use under the following conditions:

- 1 mL/min
- 8 hours per day
- 5 days per week
- Under typical lab conditions at 20 °C

Agilent InfinityLab Stay Safe caps have a GL45 thread, and install easily like standard caps and are compatible with Agilent solvent bottles.

Note: Various conditions can lead to an earlier saturation of the charcoal filter

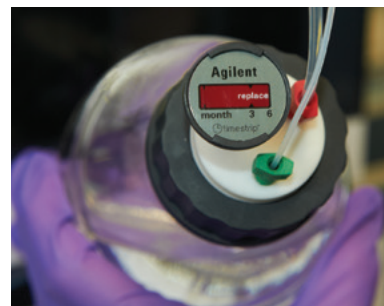

TIPS & TOOLS

To learn more about the effectiveness of Stay Safe caps, search for the technical note 5991-7755EN, at www.agilent.com/search



5043-1217



5043-1218



5043-1219



5043-1220



Stay Safe cap kit, 5043-1222

InfinityLab Stay Safe Caps

Description	Ports			Part No.
	Fittings	Vent	Filter Waste	
Stay Safe Caps				
GL45 with 1 port 1 vent valve with time strip (5043-1190)	1 x 3.2 mm	1		5043-1217
GL45 with 2 ports 1 vent valve with time strip (5043-1190)	2 x 3.2 mm	1		5043-1218
GL45 with 3 ports 1 vent valve with time strip (5043-1190)	3 x 3.2 mm	1		5043-1219
GL45 with 4 ports 1 leak hose	4 (2 x 3.2 mm, 1 x 2.3 mm, 1 x 1.6 mm)		1 1	5043-1220
Kits				
Waste can, 6 L (5043-1196)				5043-1221
Stay Safe cap GL45 with 4 ports (5043-1220)				
Stay Safe cap kit				5043-1222
Includes 4 caps (3 x 5043-1217, 1 x 5043-1218), 4 venting valves with time strip (5043-1190), 4 fittings, 3.2 mm				
For Fitting Ports				
Fitting for 3.2 mm tubing, PFA, 2/pk				5043-1216
Fitting for 2.3 mm tubing, PFA, 2/pk				5043-1215
Fitting for 1.6 mm tubing, PFA, 2/pk				5043-1214
Screw plug, 0.12 inch, PTFE, 2/pk				5043-1198
For Vent Port				
Venting valve with time strip, PTFE, 1 µm				5043-1190
For Filter Port				
Charcoal filter with time strip (58 g) for waste container				5043-1193
For Waste Port				
2-ports waste collector, PTFE				5043-1207
Screw plug, 0.25 inch, PTFE				5043-1195
Miscellaneous				
Thread adapter PTFE GL45 (M) - GL40 (F)				5043-1191
Thread adapter PTFE GL45 (M) - GPI 38-430 (F)				5043-1192
Waste can, 6 L GL45				5043-1196

Vacuum Degassers

A vacuum degasser is recommended for:

- Maximum sensitivity in the low UV wavelength range
- High injection precision
- High retention time reproducibility
- Flow rates below 0.5 mL/min

Vacuum Degasser Supplies

Description	Comments	Part No.
Vacuum Chambers and Vacuum Tubing		
Vacuum chamber replacement kit, for G1379A	Includes vacuum chambers (5067-4798) 2/pk, vacuum tubing kit (5067-5388), sheet metal bottom	5067-5387*
Vacuum tubing kit, for G1379A	Internal vacuum tubing kit (PharMed)	5067-5388
Vacuum chamber replacement kit, for G1379B	Includes vacuum chambers (5067-4798) 2/pk, vacuum tubing kit (5067-5380), sheet metal bottom	5067-5383*
Vacuum tubing kit, for G1379B	Internal vacuum tubing kit (PharMed)	5067-5380
Replacement chamber (dual channel)	For G1379A/B. Use vacuum chamber replacement kit (5067-5383) for first time installation of this type into your G1379A/B	5067-4798
Accessory Material		
Tubing kit, degasser to pump, 4/pk, 30 cm pieces of tubing with screws and bushings	For G1322A, G1379A/B, G4225A	G1322-67300
Mounting tool, for flangeless nut	For G1322A, G1379A/B, G4225A	0100-1710
Plastic tubing cutter	For inlet tubing	8710-1930
PTFE solvent tubing, 5 m, 1.5 mm id, 3 mm od	Inlet tubing	5062-2483
Ferrules, Tefzel, and lock rings, stainless steel, 0.12 inch, 10/pk		5063-6598
Nuts, polyphenylene sulfide (PPS), 0.12 inch, 1/4-28 thread, 10/pk		5063-6599
Union, 1/4-28 thread, polypropylene, 10/pk		5022-2155
Disposable syringes polypropylene, 20 mL, 10/pk	For priming the degassers. Use adapter (9301-1337) to connect to solvent lines.	5067-6624
Syringe adapter, 0.06 inch od, 2 inch long	To connect to 1/4-28 thread fittings of solvent lines	9301-1337

*Kit is required if degasser is not already equipped with new type vacuum chambers (p/n 5067-4798)

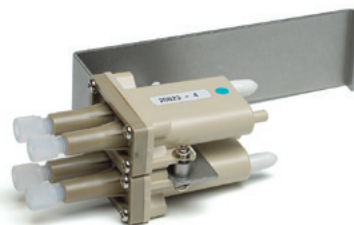

Replacement chamber (dual channel), 5067-4798



Mounting tool, 0100-1710



Plastic tubing cutter, 8710-1930



Ferrules and rings, 5063-6598



Nuts, PPS, 5063-6599



AUTOSAMPLER SUPPLIES

Your Agilent autosampler is designed to deliver accurate measurements, precise injection volumes, and high-quality data. Agilent provides a number of injection loops and trays for your application needs.



Injection Loops

Description	Comments	Part No.
For G1313, G1329, G1367, G7129, G7167 ALS, HiPALS, MLS, Vialsampler		
Multidraw kit	400 μ L/1400 μ L additional seat capillary volume for multidraw injection mode	G7167-68711
For G1313A, G1329A/B Autosampler and 1120/1220 System with Autosampler		
Sample loop, stainless steel, 100 μ L		01078-87302
Loop capillary, PEEK, for 100 μ L sample	From biocompatibility kit	G1313-87309
Loop extension capillary, stainless steel, 900 μ L	900 μ L metering required	G1313-87303
For G7129A/B Vialsampler		
Sample loop, 100 μ L	Color code: White	G7129-60500
Sample loop extension, 900 μ L	900 μ L metering required	G1313-87303
For G1367A/B/C Well Plate Sampler / High Performance Autosampler		
Loop capillary, stainless steel, 100 μ L		G1367-87300
For G1367D High Performance Autosampler		
Loop capillary, 40 μ L		G1377-87310
For G1367E, G4226A High Performance Autosampler		
Flex loop kit, 20 μ L	Color code: Red	G4226-60310
Flex loop kit, 40 μ L	Color code: Green	5067-4703
Flex loop kit, 100 μ L	Color code: Blue	5067-4710
For G5667A Bio-inert High Performance Autosampler		
Sample loop, 100 μ L (bio-inert)		G5667-81006



Sample Loop, 100 μ L, 01078-87302



Flex loop kit, 20 μ L, G4226-60310

(Continued)

Injection Loops

Description	Comments	Part No.
Multidraw kit, bio-inert, 400 bar	Includes seat capillary extensions (PEEK) for 250 μ L and 1000 μ L	G5667-68711
For G7167A/B Multisampler		
Sample loop flex, 20 μ L	Single needle option	G4267-60300
Sample loop flex, 40 μ L	Single needle option	G4267-60400
Sample loop flex, 100 μ L	Single needle option	G4267-60500
Sample loop flex, 500 μ L	Single needle option	G7167-68500
Sample loop flex, 900 μ L	Single needle option	G7167-68900
Upgrade kit sample loop flex, 500 μ L, right	Single needle option, includes loop and needle, requires 500 μ L metering device	G7167-68500
Upgrade kit sample loop flex, 900 μ L, right	Single needle option, includes loop and needle, requires 900 μ L metering device	G7167-68900
Sample loop flex, 500-900 μ L, right	Loop cartridge, sub assembly of G7167-68500/ G7167-68900	G7167-60300
Sample loop flex, 20 μ L, right	Dual needle option	G4267-60311
Sample loop flex, 20 μ L, left	Dual needle option	G4267-60301
Sample loop flex, 40 μ L, right	Dual needle option	G4267-60411
Sample loop flex, 40 μ L, left	Dual needle option	G4267-60401
Sample loop flex, 100 μ L, right	Dual needle option	G4267-60511
Sample loop flex, 100 μ L, left	Dual needle option	G4267-60501
Sample loop flex, 500 μ L, right	High volume option, dual needle option	G7167-68511
Sample loop flex, 500 μ L, left	High volume option, dual needle option	G7167-68501
Sample loop flex, 900 μ L, right	High volume option, dual needle option	G7167-68911
Sample loop flex, 900 μ L, left	High volume option, dual needle option	G7167-68901
Flex extension left dual needle	Loop cartridge, sub assembly of G7167-68501/ G7167-68901	G7167-60301
Flex extension right dual needle	Loop cartridge, sub assembly of G7167-68511/ G7167-68911	G7167-60311
For G5668 Bio-inert Multisampler		
Sample loop, bio-inert, 100 μ L		G5668-60500

Sample loop flex, 100 μ L, G4267-60500*(Continued)*



Multidraw loop, 5 mL, for preparative autosampler,
G2260-68711

Injection Loops

Description	Comments	Part No.
Multidraw kit, bio-inert, 400 bar	Includes seat capillary extensions (PEEK) for 250 μ L and 1000 μ L	G5667-68711
For G1377A High Performance Micro Autosampler		
Loop capillary, 8 μ L		G1375-87315
Loop capillary, 40 μ L		G1377-87300
For G2260A Preparative Autosampler		
Multidraw loop, 5 mL		G2260-68711
For G2258A Dual-loop Autosampler		
Buffer loop tubing assembly, PTFE		G2258-87300
Buffer loop extension assembly		G2258-60002
Capillary loop, 2 μ L, stainless steel		5068-0031
Capillary loop, 5 μ L, stainless steel		5068-0032
Capillary loop, 10 μ L, stainless steel		5068-0051
Capillary loop, 20 μ L, stainless steel		5068-0033
Capillary loop, 50 μ L, stainless steel		5068-0034
Capillary loop, 100 μ L, stainless steel		5068-0035
For G4278A LC Injector HTC / G4277A LC Injector HTS		
Loop, 2 μ L, Cheminert injection valve		5188-6457
Loop, 10 μ L, Cheminert injection valve		5188-6458
Loop, 20 μ L, Cheminert injection valve		5188-6459
Loop, 50 μ L, Cheminert injection valve		5188-6460
Loop, 100 μ L, Cheminert injection valve		5188-6461
Loop, 250 μ L, Cheminert injection valve		5188-6462
Loop, 500 μ L, Cheminert injection valve		5188-6463
Loop, 1000 μ L, Cheminert injection valve		5188-6464
Loop, 2000 μ L, Cheminert injection valve		5188-6465
Loop, 5000 μ L, Cheminert injection valve		5188-6466
Loop, PEEK 2 μ L, Cheminert injection valve		5188-6469
Loop, PEEK 5 μ L, Cheminert injection valve		5188-6470
Loop, PEEK 10 μ L, Cheminert injection valve		5188-6467
Loop, PEEK 20 μ L, Cheminert injection valve		5188-6468

Autosampler Trays

Description	Comments	Part No.
For G1313A, G1329A/B, G2260A, 1120/1220 Autosampler		
100 position tray, for 2 mL vials		G1313-44510
100 position tray, for 2 mL vials	Thermostatable	G1329-60011
40 position tray, for 2 mL vials	Halftray	G1313-44512
15 position tray, for 6 mL vials	Halftray	G1313-44513
External vial tray, for 17 vials (disposal position)		G1313-60004
Disposal tube, for external vial tray		G1313-27302
For G7129A/B Vial Sampler		
Drawer, for 66 x 2 mL vials	66 position tray	G7129-60010
Drawer, for 18 x 6 mL vials	18 position tray	G7129-60110
Drawer kit, for 100 x 2 mL vials	50 position tray, 2/pk Classic set up	G7129-68210
External tray, for 5 x 2 mL vials		G7129-60000

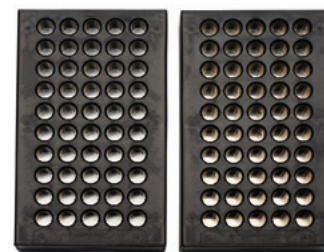

Various trays for autosampler modules

Drawer kit, for 100 x 2 mL vials,
G7129-68210*(Continued)***TIPS & TOOLS**

Agilent has made vial, cap, and septum selection easy with its new Interactive Vial Selection Tool, available online in both desktop and mobile versions. The tool identifies the right vial and closures for your particular application, and provides the rationale for the choices offered.

Visit www.agilent.com/chem/SelectVials



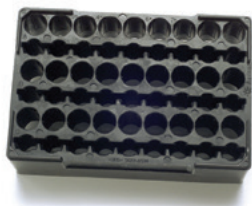

Plate for 27 Eppendorf Safe-lock tubes, 5022-6538



Standard drawer kit for multisampler, double-height (2H), G7167-60020



Vial plate for 54 x 2 mL vials, G2255-68700



Vial plate for 15 x 6 mL vials, 5022-6539

Autosampler Trays

Description	Comments	Part No.
For G1367A/B/C/D/E, G2258A, G4226A		
Well plate tray	Hosts maximum 2 well plates or vial plates plus 10 vials	G2258-60011
Vial plate, for 54 x 2 mL vials, 6/pk		G2255-68700
Vial plate, for 15 x 6 mL vials		5022-6539
Vial plate, for 40 x 2 mL vials		5023-2471
100 position tray, for micro vials	Not for G2258A	G4226-60021
Plate for 27 Eppendorf safe-lock tubes, 0.5/1.5/2 mL		5022-6538
For G7167A/B Multisampler		
Additional standard drawer kit, double-height (2H)	Hosts maximum 2 vial plates (54 x 2 mL, 40 x 2 mL) or 2 well plates Includes sample trays, 2/pk	G7167-60020
Additional drawer kit, single-height (1H), 2/pk	Host maximum 2 well plates Includes sample trays, 2/pk	G7167-60021
Additional drawer kit, triple-height (3H), 2/pk	Hosts maximum 2 vial plates (4 x 2 mL, 40 x 2 mL, 15 x 6 mL) Includes sample trays, 2/pk	G7167-60022
Sample trays, for drawer (1H)		G4267-60206
Sample tray for drawers (2H/3H)		G4267-60205
Vial plate, for 54 x 2 mL vials, 6/pk		G2255-68700
Vial plate, for 15 x 6 mL vials		5022-6539
Vial plate, for 40 x 2 mL vials		5023-2471

Injection Valve Supplies

Rotors

The rotor is a highly stressed part of the autosampler that is constantly switched back and forth, sliding over the stator. Its material and surface finish govern its durability and lifetime. Comparison of Agilent and third-party rotor seals has revealed major differences in these aspects.

Lifetime

Agilent rotors are tested to ensure the longest possible lifetime. After rigorous tests, the Agilent rotor surface still seemed flat and consistent, and the contacting stator surface appeared clean. In contrast, the third-party rotor already showed severe surface damage and a contaminated stator surface after 10 % fewer switch cycles. Therefore, shorter lifetime and potential carryover and leakage are expected when using third-party seals.

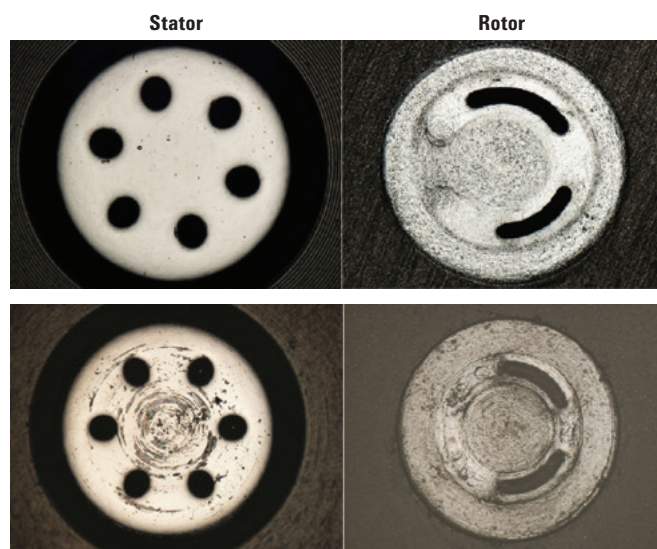

Stator and rotor after rigorous tests of an Agilent rotor seal, with clean and flat surfaces.

Stator and rotor after 10 % fewer switch cycles of a third-party rotor seal, showing early damage.

Injection Valve Supplies

Valve	Use with	Rotor Seal		Stator	Additional Parts
		Material	Rotor Seal		
2 position/6 port injection valve, 400 bar	G1313A, G1329A, G1367A/B, 1120	Vespel	0100-1853	0100-1850	Stator face p/n 0100-1851 Service kit p/n 0101-1257
		Tefzel	0100-1849		
		PEEK	0100-2231		
2 position/6 port injection valve, 600 bar	G1329B, G1367C, G1367D, G1367E, 1220 Infinity LC	PEEK	0101-1416	0101-1417	
Bio-inert 2 position/6 port injection valve	G5667A	PEEK	5068-0099	5068-0060	Stator face p/n 0100-1851 Bearing ring p/n 1535-4045
Bio-inert 2 position/6 port injection valve head	G5668A	PEEK	5068-0209	5068-0060	Stator face p/n 0100-1851 Bearing ring p/n 1535-4045
2 position/6 port ultra high pressure valve, 1200 bar	G4226A	Vespel	5068-0007	5068-0006	
2 position/6 port injection valve, vial sampler	G7129A	PEEK	0101-1416	5068-0215	Bearing ring p/n 1535-4045
2 position/6 port injection valve, 1300 bar, vial sampler	G7129B	Vespel	5067-0007	5068-0216	Bearing ring p/n 1535-4045
2 position/6 port injection valve, multisampler	G7167A	PEEK	5068-0209	5068-0208	Bearing ring p/n 1535-4045
2 position/6 port injection valve, 1300 bar, multisampler	G7167B	PEEK	5068-0198	5068-0197	Bearing ring p/n 1535-4045
2 position/6 port micro injection valve, 400 bar	G1377A, G1389A	Vespel	0100-2088	0100-2089	
2 position/10 port injection valve	G2258A	Vespel	0100-2415	0101-1390	
2 position/6 port MBB injection valve, 400 bar	G2260A	PEEK	0101-1268	0100-2195	Service kit p/n 0101-1268
2 position/6 port injection valve, 1200 bar, PAL Injector (CTC), (p/n 5067-4123)	G4277A, G4278A	Vespel	5068-0030	5068-0029	
2 position/6 port injection valve, 1200 bar, for PAL ALS (p/n 5067-4261)	G4277A/G4278A	Vespel	5068-0234	5068-0235	Bearing ring p/n 1535-4045
2 position/6 port injection valve, 600 bar, CTC	G4270-CTC/G4271-CTC	PEEK	5188-6492*		

*Rotor seal is part of RheBuild kit, 5188-6492



Stator for 2 position/6 port switching valve, 600 bar,
0101-1417

Needles and Needle Seats

The needle should be replaced when it becomes bent, burred, or blunt, or when it is leaking or plugged. Suspect a leak if you notice a trail of buffer crystals on the needle seat. If the sample contains particulates the needle seat can become blocked, as this is the first restriction that the sample experiences. If this occurs, try backflushing the needle seat capillary.

Needles and Needle Seats

Agilent Autosampler	Needle Assembly Description	Part No.	Compatible with Needle Seat	Part No.
Standard Autosamplers and Vial Samplers				
G1313A, G1329A/B, 1120, 1220 Infinity LC	Needle assembly, standard autosampler	G1313-87201	Standard needle seat, PEEK, 0.17 mm id capillary, 2.3 µL	G1329-87017
			Standard needle seat, PEEK, 0.12 mm id capillary, 1.2 µL	G1329-87012
G1313A, G1329A, 1120, 1220	Needle assembly, for use with PEEK seat	G1313-87203	Standard needle seat, PEEK, 0.17 mm id capillary, 2.3 µL	G1313-87102
G1313A, G1329A/B, 1120/1220	Needle, 900 µL	G1313-87202	Standard needle seat, PEEK, 0.17 mm id capillary, 2.3 µL	G1329-87017
G7129A	Needle 1260 Infinity autosampler	G7129-87200	Seat assembly, PEEK, 0.17 mm	G7129-87017
G7129B	Needle assembly 1290 Infinity II vialsampler	G7129-87201	Seat assembly, PEEK, 0.12 mm	G7129-87012
G7129A	Needle assembly (slotted), for high injection volumes	G7129-87202	Seat assembly, PEEK, 0.17 mm	G7129-87017
G1389A	µ-LC needle for G1329 autosampler	G1329-80001		
G1313A, G1329A/B G1389A, G2260A, 1120/1220			Seat adapter	G1313-43204

(Continued)



Needle assembly 1290 vialsampler,
G7129-87201



Needle seat, PEEK, 600 bar, 0.12 mm id,
G1367-87012



Needle assembly multisampler,
G4267-87201



Seat adapter,
G1313-43204

Needles and Needle Seats

Agilent Autosampler	Needle Assembly Description	Part No.	Compatible with Needle Seat	Part No.
Well Plate/ High Performance Autosampler / Multisampler				
G1367A/B	Needle assembly, standard well plate sampler	G1367-87201	Needle seat Vespel, well plate autosampler (0.17 mm id capillary, 2.3 µL)	G1367-87101
G1367C	Needle assembly G1367D	G1367-87202	Low carry over seat, PEEK, 0.17 mm	G1367-87017
G1367D	Needle assembly G1367D	G1367-87202	Low carry over seat, PEEK, 0.12 mm	G1367-87012
G1367E	Needle assembly	G4226-87201	Low carry over seat, PEEK, 0.12 mm	G1367-87012
G4226A	Needle assembly	G4226-87201	Seat assembly, Vespel, 0.12 mm, 1290 Infinity LC	G4226-87012
G7167A/B	Needle assembly multisampler	G4267-87201	High pressure needle seat, PEEK, 0.12 mm	G4267-87012
	Needle assembly (slotted), for high injection volumes	G4267-87210		
	Needle assembly, ultra low dispersion	G4267-87020		
Bio-inert Samplers				
G5667A	Bio-inert needle assembly	G5667-87200	Bio-inert seat assembly, for high performance autosampler	G5667-81008
G5668A	Needle bio-inert multisampler	G5668-87200	Bio-inert seat assembly, for multisampler	G5668-87017
Preparative Scale / Micro Scale Autosamplers				
G2258A	Needle kit	G2258-68710	Twin needle seat, dual loop autosampler	G2258-87102
G2260A	Needle assembly, preparative autosampler	G2260-87201	Needle seat, preparative autosampler 0.5 mm id, 20 µL	G2260-87101
G1377A	Needle assembly, microwell plate sampler	G1377-87201	Micro needle seat, with seat capillary, 100 µm	G1377-87000
			Micro needle seat, with seat capillary, 75 µm	G1377-87001
			Micro needle seat, with seat capillary, 50 µm	G1377-87002
			Micro needle seat	G1377-87101
HTC/HTS/CTC LC Injectors				
G4277A, G4278A	PEEK needle seal, Valco, 22 gauge, 10/pk	5188-6476		
G4277A, G4278A	PTFE needle seal, Valco, 22 gauge, 10/pk	5188-6477		
G4277A, G4278A	DLW 1 needle kit	G4277-80125	Needle seal, Rheodyne 7991, 22 gauge	5188-6478
G4277A, G4278A	DLW 2 holding loop (stainless steel) assembly with needle	G4277-60602	Needle seal, Rheodyne 7991, 22 gauge	5188-6478
G4270/71 - CTC	Syringe needle	9301-0407		
G4277A, G4278A			PAL3 needle seat, PEEK	5188-8052
Needle Wash Parts				
G1367A-E, G1377A, G4226A, G5667A, G7129A/B,	Peristaltic pump cassette with PharMed tubing	5065-4445		
	Tubing, PTFE, 5 m (1.6 mm od, 0.7 mm id)	5062-2462		

Metering Device Supplies

Infrequently, the metering device seal and piston may need replacement if you see loss in injection volume precision or metering device leaking.

Metering Device Supplies

Agilent Autosampler	Piston Description	Part No.	Metering Seal	Part No.
Standard Autosamplers and Vialsamplers				
G1313A, G1329A/B, G1367A/B/C, G1367E, 1120/1220	Piston, sapphire, 100 μ L	5063-6586	Piston seal, PTFE, 2/pk	5063-6589
G7129A	Piston, ceramic, 100 μ L	5067-5678	Piston seal, PTFE, 2/pk	5063-6589
G7129B	Piston, ceramic, 40 μ L	5067-5920	Metering seal, 40 μ L	0905-1717
G7129A, G7167A (high volume option)	Piston assembly, 900 μ L	G4267-60462	Metering seal, 900 μ L	0905-1294
Well Plate/ High Performance Autosampler / Multisampler				
G1367D, G1389A, G1377A	Piston, sapphire, 40 μ L	5064-8293	Piston seal, 2 mm	5022-2175
G4226A	Piston, sapphire, 40 μ L	5064-8293	Metering seal, 40 μ L	0905-1717
G7167A	Piston, ceramic, 100 μ L	5067-5678	Metering seal, 100 μ L	0905-1719
G7167B	Piston, ceramic, 40 μ L	5067-5620	Metering seal, 40 μ L	0905-1717
G7167A/B multiwash option flushhead	Piston assembly, 500 μ L	5067-5919	Seal, 500 μ L	5067-5918
CTC, G4277, G4278	DLW syringe, 100 μ L	G4277-80120	DLW syringe plunger, for 100 μ L syringe	G4277-80122

(Continued)



Piston assembly (40 μ L) for G7129B, 5067-5920



Piston seals, 5063-6589

Metering Device Supplies

Agilent Autosampler	Piston Description	Part No.	Metering Seal	Part No.
Bio-inert Samplers				
G5667A	Piston, sapphire, 100 µL	5063-6586	Piston seal (bio-inert)	G5611-21503
G5668A	Piston, ceramic, 100 µL	5067-5678	Piston seal (bio-inert)	G5611-21503
Preparative Scale / Micro Scale Autosamplers				
G2258A	Piston, 5 mL	G2258-60003	Piston seal	0905-1599
G2260A	Piston assembly, 900 µL	5062-8587	Metering seal, 900 µL	0905-1294
G1389A, G1377A	Piston, sapphire, 40 µL	5064-8293	Piston seal, 2 mm	5022-2175

Accessories

Description	Use With	Part No.
Seat adapter	G1313A, G1329A, G1389A, G2260A, 1120 and 1220 Infinity LC	G1313-43204
Finger caps, for autosampler gripper, 15/pk	G1313A, G1329A/B, G1389A, G2260A, G7129A/B, 1120 and 1220 Infinity LC	5063-6506
Tool, for micro seat capillary mounting	G1377A	G1377-44900
Seat extension capillary, 0.5 mL, 0.5 mm id	G1329A/B	G1313-87307



Sapphire piston, 5062-8587

Easy-to-use hardware available in all chemistries

High-performance Agilent UHPLC guards are designed for use with fast LC columns. They connect directly to the column inlet; no extra hardware is needed.

Agilent UHPLC guards are available in all InfinityLab Poroshell 120 chemistries—giving you confidence that the guard column will not adversely affect your separations.

Turn to **Pages 128–131** to find out more.



Autosampler Kits

Autosampler Kits

Description	Kit Contents	Part No.
Upgrade Kits		
Multidraw upgrade kit, for G1313A, G1329A/B, G7129A/B, G7167A/B (no dual loop, requires 900 μ L option)	Includes 500 μ L and 1500 μ L seat extension capillary, ZDV union, and installation instructions	G7167-68711
Large volume injection kit, for the Agilent 1290 Infinity LC autosampler G4226A	Includes 1200 bar multidraw technical note, capillary seat, 80 μ L, 0.5 mm id, 0.9 mm od	G4216-68711
Flex loop kit, 40 μ L, for the Agilent 1290 Infinity LC autosampler G4226A	Increases the maximum draw volume of the autosampler	5067-4703
Door Replacement Kits		
Cabinet upgrade kit, for 1260 Infinity LC sampler	Includes side panel, top cover, and front door	G1329-68736
Cabinet kit, for G1367E and G4226A	Includes side panel, base plate, and top cover	5067-4662
Door replacement kit, for 1260 Infinity LC sampler	Includes front and side doors	G1329-68737
Door repair kit, for G1367E and G4226A	Includes front door and carrier bolt	G4226-67001
Light protection kit, for G1329A	Includes opaque front, side doors, and front cover	G1329-68718
Door replacement kit, for G1329A	Includes transparent front and side doors	G1329-68727



Cabinet upgrade kit, for 1260 Infinity LC sampler, G1329-68736



Collection plate, showing 96-position closing mat, 5042-1389

Well Plates and Closing Mats

Well Plates and Closing Mats

Description	Sample Volume	Material	Certified	Unit	Part No.
384-well plate	90 μ L	Polypropylene		30/pk	5042-1388
96-well plate, skirted	150 μ L			25/pk	5042-8502
96-well plate, with glass inserts, caps, septa preassembled	350 μ L			1/pk	5065-4402
96-well plate	500 μ L	Polypropylene		120/pk	5042-1385
96-well plate	500 μ L	Polypropylene		10/pk	5042-1386
96 deep-well plate	1 mL	Polypropylene		50/pk	5042-6454
Insert and cap/septa kit, for deep-well collection plates. Includes 350 μ L inserts and caps/septa. Ideal for refilling kit 5065-4402.			Y	1000/pk	5190-2237
Closing mat, micro mat, square, for 96-well plate				10/pk	SN800220
Closing mat, for 96-well plate		Silicone		50/pk	5042-1389

Vials and Sample Containment Solutions

Save Money, and Eliminate Drains on your Labs Productivity



Screw cap, bonded, blue, PTFE/white silicone septa, 5190-7021



A-Line screw top vial, 2 mL, clear, with write-on spot, 5190-9589



A-Line screw top vial, 2 mL, amber, with write-on spot, 5190-9590

Using poor-quality vials (or the wrong vials for your application) can cause sequence problems, unnecessary downtime, expensive repairs, and the loss of your precious samples.

Agilent A-Line vials are produced from the best sourced glass in the range-type 1 borosilicate, 51 coefficient of expansion glass. This type of glass will not remove analytes from your sample matrixes, meaning that Agilent A-Line vials are the ultimate solution for your precious samples. In addition, they are the only vials that deliver time and cost-saving advantages like these:

- **Maximum inertness:** The inert performance of Agilent A-Line vials, results in reduced analyte peak variability, so you can have the utmost confidence in your results.
- **Consistent performance:** Vial-to-vial lot-to-lot Agilent A-Line vials demonstrate consistent performance, so you spend less time troubleshooting and rerunning samples.
- **Certification of analysis:** Agilent A-Line vials come with a certificate of analysis, so you can be sure that they will perform even in the most demanding environments.
- **Designed to fit a range of caps:** Agilent A-Line vials can be used with your existing 2 mL autosampler caps, for easier inventory management.
- **Fewer septa issues:** Agilent septa are continually being improved to limit leaching, coring, sticking, push-through, hardness, and adsorption/absorption.
- **Fast delivery:** Our worldwide distribution centers can make sure that your order reaches your lab within 48 hours.

Agilent A-Line vials: Better analyte retention over time

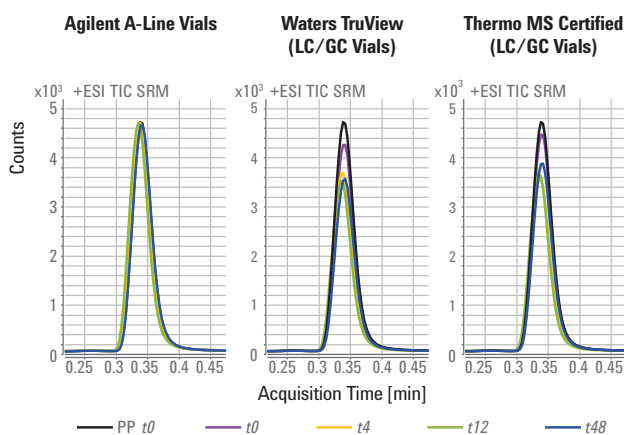

Agilent A-Line vial shows superior analyte retention in this separation of doxepin.

Note: Tests were carried out by Agilent.

Vials and Sample Containment Solutions

Description	Part No.
Vials	
A-Line screw top vial, 2 mL, clear, with write-on spot, 100/pk	5190-9589
A-Line screw top vial, 2 mL, amber, with write-on spot, 100/pk	5190-9590
A-Line crimp top vial, 2 mL, clear, with write-on spot, 100/pk	5190-9591
A-Line crimp top vial, 2 mL, amber, with write-on spot, 100/pk	5190-9592
Caps	
Screw cap, bonded, blue, PTFE/white silicone septa, 100/pk	5190-7021
Screw cap, bonded, blue, preslit, PTFE/white silicone septa, 100/pk	5190-7023*
Crimp cap, silver aluminum, PTFE/white silicone septa, 100/pk	5182-0552

*Recommended for high volume injections



Press fit VS bonded caps

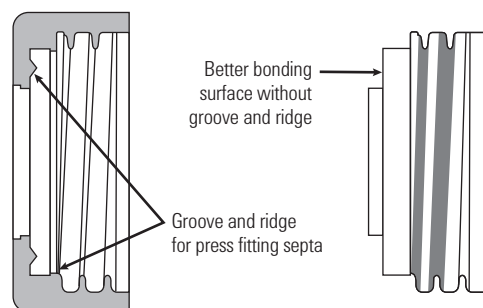

HUNDREDS OF CHOICES... ONE EASY GUIDE

Use our online selection tool to quickly find the right products for complete confidence in your sample containment.

- Answer a few simple questions to identify your best options
- Search by technique, product number, or vial type
- Make a perfect pick from more than 600 vials, caps, and septa

To access the tool, and for product brochure, white papers, free poster, and more, go to: www.agilent.com/chem/vialsresources





FRACTION COLLECTOR SUPPLIES

Agilent fraction collectors are designed to process data in real-time for instantaneous and precise fraction collection, while increasing throughput on your purification system. So you can be certain that you are getting the highest degree of recovery and purity for your fractions—even with low flow rates.

The Agilent 1290 Infinity II preparative open-bed fraction collector enables high-capacity fraction collection of purified peaks for semipreparative and preparative-scale LC purification with:

- **High flexibility and throughput** enabling collection of up to 432 fractions, or a volume up to 5.9 L
- **Lowest delay volumes** minimizing peak dispersion and carryover between fractions
- **Accurate peak collection** with unique automated delay sensor
- **Bio-inert flowpath** ideal for protein purification



1290 Infinity II preparative OpenBed fraction collector, G7159B



Fraction Collector Maintenance Schedule

Procedure	When to Perform
Analytical and Preparative Fraction Collector Maintenance	
Replace the inlet/waste tubing	Once per year, or when you notice signs of damage or wear
Replace the valve-to-needle tubing	Once per year, or when you notice signs of damage or wear
Exchange the preparative needle assembly	When the needle shows signs of damage or blockage
Exchange the analytical needle assembly	When the needle shows signs of damage or blockage, or when using the short needle assembly with tall test tubes (>45 mm)
Exchange the diverter valve	When the valve is leaking or not switching properly
Exchange the internal tray	When the flow delay sensor no longer works
Repair or exchange a funnel within the internal tray or funnel tray	When defective, leaky, blocked, or contaminated
Micro Fraction Collector/Spotter Maintenance	
Replace fraction collector capillary	At least every six months or when worn, blocked, or damaged
Exchange the capillary guiding assembly	When bent or damaged
Exchange the internal tray	When the flow delay sensor no longer works properly
Exchange the flap septum and waste tubing	At least every six months or when defective or contaminated



Test Tubes

Tube Dimensions (id x Height)	Volume	Use With	Unit	Part No.
12 x 100 mm	8 mL	G1364B, G7159B	250/pk	5022-6531
12 x 150 mm	11 mL	G7159B	250/pk	5190-9093
16 x 100 mm	13 mL	G1364B, G7159B	250/pk	5022-6532
16 x 150 mm	21 mL	G7159B	250/pk	5190-9092
25 x 100 mm	35 mL	G1364B, G7159B	100/pk	5042-6459
25 x 150 mm	55 mL	G7159B	100/pk	5190-9091
30 x 100 mm	58 mL	G1364B, G7159B	100/pk	5042-6458
30 x 150 mm	85 mL	G7159B	100/pk	5190-9090

Trays for Fraction Collectors (G1364B/C)

Hole Diameter (mm)	No. of Tubes	Tray Part No.
30	40	G1364-84523
25	60	G1364-84524
16	126	G1364-84525
12	215	G1364-84516

Funnel Trays for Fraction Collectors (G1364BC)

Description	Part No.
Half tray, for 40 funnels	G1364-84532
Tray, for 2 well plates and 10 collecting funnels	G1364-84522
Funnel seal kit, 10/pk	G1364-68730
Tubing kit, 10 tubes	G1364-86707



Funnel tray for G1364C fraction collector,
G1364-84532

InfinityLab Tube Containers and Drawer (G7159B)

Description	Part No.
Drawer for G7159B, ambient temperature	G9321-60085
Tube container, 30 x 150 mm, 10 tubes, ambient	G9321-60015
Tube container, 30 x 100 mm, 10 tubes, ambient	G9321-60058
Tube container, 25 x 150 mm, 18 tubes, ambient	G9321-60025
Tube container, 25 x 100 mm, 18 tubes, ambient	G9321-60035
Tube container, 16 x 150 mm, 36 tubes, ambient	G9321-60129
Tube container, 16 x 100 mm, 36 tubes, ambient	G9321-60055
Tube container, 12 x 150 mm, 72 tubes, ambient	G9321-60131
Tube container, 12 x 100 mm, 72 tubes, ambient	G9321-60045

Note: The drawers and containers of the fraction collector use RFID tags to detect the dimensions of test tubes automatically.



Tube container, G9321-60055
and drawer, G9321-60085

1290 Infinity II LC OpenBed Fraction Collector Supplies (G7159B)

Description	Part No.
1290 Infinity II HiP preparative fraction collector tubing kit, 50 mL/min	G9321-60952
1290 Infinity II HiP preparative fraction collector tubing kit, 200 mL/min	G9321-60951
Fitting 1/4-28, for tube od 2.5 mm, ESD-PEEK	5023-2871
Fitting 1/4-28, for tube od 2.0 mm, ESD-PEEK	5023-2872
Fitting 1/4-28, for tube od 1.4 mm, ESD-PEEK	5023-2874
Delay calibrant	G9321-60592

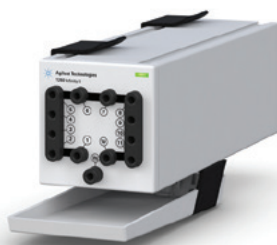

1260 Infinity II preparative valve-based fraction
collector, G7166A

1260 Infinity II Preparative Valve-Based Fraction Collector Supplies (G7166A)

Description	Part No.
PTFE tubing, ESD-stripped, 1.6 mm id, 2.5 mm od, 6 m length	5023-2882
PTFE tubing, ESD-stripped, 1.2 mm id, 2.0 mm od, 2 m length	5023-2878
Fitting, 1/4-28, tube, 2 mm od, ESD-PEEK	5023-2872
Fitting, 1/4-28, for od 2.5 mm, ESD-PEEK, 6/pk	5023-2883
Tubing, polyurethane, 4 mm x 6 mm, 2 m	3710043100
Elbow, 6 mm push fit x male 1/8 BSP	1610140200

Fraction Collector Capillary Kits and Needles

Module	Max Flow Rate	Tube Size	Tubing Kit	Needle Length	Needle	Typical Use
G1364B	100 mL/min	0.8 mm id	G1364-68711		G1364-87201	Tubes (max 100 mm)
G1364C	1 mL/min	0.15 mm id	G1364-68723	50 mm	G1367-87200	Tubes (max 48 mm), well plates, vials
	10 mL/min	0.25 mm id	G1364-68712	50 mm	G1367-87200	
	10 mL/min	0.25 mm id	G1364-68712	20 mm	G1364-87202	Funnel tray (tubes max 75 mm)
	100 mL/min	0.8 mm id	G1364-68711	20 mm	G1364-87202	
G1364D	4 µL/min	25 µm id	G1364-87304			MALDI targets, well plates
	4-30 µL/min	50 µm id	G1364-87305			
	30-100 µL/min	100 µm id	G1364-87306			
G7159B	50 mL/min		G9321-60952			
G7159B	200 mL/min		G9321-60951			

TIPS & TOOLS

Information on maintenance procedures can be found at www.agilent.com/chem/LCmaintenancenotes

Micro Fraction Collector Supplies for G1364D



MALDI spotting adapter, for G1364D, G1364-83205



Well plate adapter assembly for G1364C/D, G1364-60021

Description	Part No.
MALDI spotting adapter, for G1364D	G1364-83205
Well plate adapter assembly, for G1364C/D	G1364-60021
Flap septum, PEEK, for internal tray	G1364-27107
Capillary, fused silica/PEEK, 25 μ m, 50 cm	G1364-87304
Capillary, fused silica/PEEK, 50 μ m, 50 cm	G1364-87305
Capillary, fused silica/PEEK, 100 μ m, 50 cm	G1364-87306
Waste tube, PTFE, 20 cm, 1.4 mm id, 2.0 mm od	G1364-86711
MALDI plate carrier, Bruker PAC	5022-6546
MALDI plate carrier, ABI Opti-TOF	5023-0238
MALDI plate carrier, Agilent	5022-6543
Target plate, for AP-MALDI LC/MS	G1972-60025
On-line matrix kit, for MALDI spotting Includes BCD board/cable, syringe, needles, adapters, connector, and capillary	G1364-68706
Adapter, union, PEEK 1/4-28	5042-8517
Adapter, male Luer to female 1/4-28	5042-8518
Micro T-connector, PEEK, swept volume 29 nL, with 1/32 inch id fittings	5042-8519
MALDI spotting tips, PTFE, 10/pk	G1364-81701

TIPS & TOOLS

Filter samples prior to analysis to ensure that fine particulates don't affect your LC system or results.

Our syringe filter online selection guide makes it fast and easy to choose the best syringe filter for your application. Try it now at:

www.agilent.com/chem/selectfilters

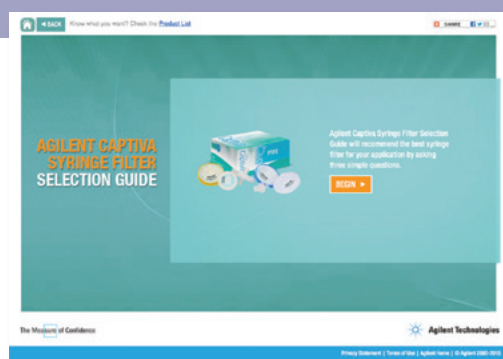

THERMOSTATED COLUMN COMPARTMENT/MULTICOLUMN THERMOSTAT AND VALVE SUPPLIES



InfinityLab column ID tags

Get the information you need for the highest-quality results on your InfinityLab LC Series instrument.

Column ID tags allow you to track various column properties and usage parameters including, but not limited to: column identity, lot and batch number, the last injection date, number of injections, and the maximum temperature used. Column ID tags ensure traceability of analysis, making documenting columns and conditions for routine analysis easy and adding confidence to any analysis.



InfinityLab column ID tag, 5067-5917

- **Usability** – Easily find column details
- **Traceability** – Always know exactly which column is/was installed
- **Security** – Protect against the use of methods incompatible with the column

Column Compartment Supplies

Description	Comments	Part No.
Number clip kit, 1–8, colored, for columns and fittings	Clips for number and color coding your connections and columns in multicolumn selection setups, 24 clips, numbered from 1–8, three sets of each color	5067-6654
For Thermostated Column Compartment (G1316A/B/C)		
Bio-inert low dispersion heat exchanger		G5616-81000
Column clamp, 6/pk		5063-6526
Column holder for micro LC columns	Helps fixing micro LC columns to the TCC's heater element	5001-3702
Low dispersion heat exchanger double kit (0.12 mm id, 1.6 µL volume)	Supports 2 channels, female connectors at in- and outlet side allows the connection of various capillaries (G1316B/C)	G1316-80022
Thermal column insulation enclosure kit	Reduces RI baseline wander effects at high ACN content water mixtures in combination with amino-functionally columns	G1316-60001

(Continued)

TIPS & TOOLS

Check out InfinityLab fittings and capillaries for more information on making the perfect connection. Turn to **Pages 103–106** or visit www.agilent.com/chem/infinitylabfittings

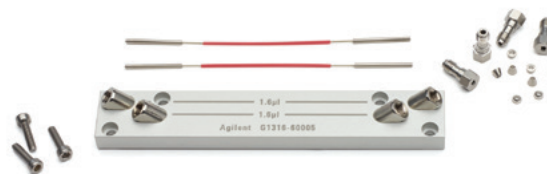

Low dispersion heat exchanger double kit for G1316B/C, G1316-80022

Column Compartment Supplies

Description	Comments	Part No.
For G7116A/B Multicolumn Thermostat		
InfinityLab Quick-Connect heat exchanger, standard (0.12 mm id, 1.6 µL volume)	Standard Quick-Connect heat exchanger for G7116B	G7116-60015
InfinityLab Quick-Connect heat exchanger, high flow (0.12 mm id, 3.0 µL volume)		G7116-60031
InfinityLab Quick-Connect heat exchanger, large id (0.17 mm id, 3.0 µL volume)	Standard Quick-Connect heat exchanger for G7116A	G7116-60051
InfinityLab Quick-Connect heat exchanger, large id, high flow (0.17 mm id, 6.0 µL volume)		G7116-60061
InfinityLab Quick-Connect heat exchanger, bio-inert (0.17 mm id)	Includes Quick Connect fitting and UHP-FF fitting	G7116-60009
InfinityLab Quick-Connect heat exchanger, bio-inert (0.17 mm id)	No fittings included	G7116-60041
Low dispersion kit, for Agilent 1290 Infinity II LC	Includes Quick-Connect heat exchanger (0.075 mm id, 1.1 µL volume) and connecting capillaries	5067-5963
InfinityLab column ID tag assembly (programmable)	Column ID reader option required, can also be used with Internal Column Compartment of G7129A/B	5067-5917
Column holder clips, soft, 2/pk		G7116-68003
Column holder clamp, 2/pk		G7116-68004
Rotor seal, PEEK, for 4-column switching valve, 600 bar		5068-0264
Rotor seal, PEEK, for 2 position/6 port valve, 600 bar		0101-1409
Rotor seal, PEEK, for 2 position/10 port valve, 600 bar		0101-1415
Rotor seal, PEEK, for 8-column switching valve, 1300 bar	G7116B	5068-0200
Column Connect Capillaries		
InfinityLab Quick Connect assembly, stainless steel, 0.12 x 105 mm	Quick Connect fitting, with premounted capillary	5067-5957
InfinityLab Quick Connect assembly, stainless steel, 0.17 x 105 mm	Quick Connect fitting, with premounted capillary	5067-6166
Column connection capillary, 0.17 x 90 mm	Includes 2 nonswaged steel fittings male	G1316-87300
Column connection capillary, 0.12 x 70 mm	Includes 2 nonswaged steel fittings male	G1316-87303
Column connection capillary, 0.12 x 180 mm	Includes 2 nonswaged steel fittings male	G1313-87304
Column connection capillary, 0.17 x 180 mm	Includes 2 nonswaged steel fittings male	G1313-87305



Column holder clamp, 2/pk, G7116-68004

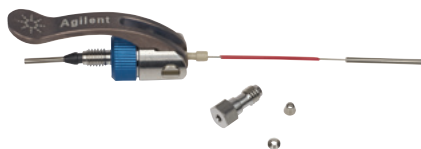

InfinityLab Quick Connect assembly, 5067-5957



InfinityLab Quick-Connect heat exchangers, G7116-60015 and column holder clips, soft, G7116-68003 for the MCT

Valve Supplies

Agilent's industry-leading manual injection valves are designed to ensure trouble-free operation with your HPLC System.

Our valves also feature patented Make-Before-Break architecture that allows you to switch between *load* and *inject* positions without interrupting the flow. So you can analyze more samples in less time.



Valve Maintenance Notes

- **Vespel** is a polyimide with low wear and high chemical resistance. Vespel tolerates a pH range of 0 to 10. More basic solutions dissolve Vespel, which damages the rotor seal
- **PEEK** offers a high chemical resistance and versatility, and will tolerate the entire pH range from 0 to 14
- **Tefzel** is recommended for use in applications where PEEK cannot be used, such as methylene chloride or DMSO in higher concentrations



pH Range	0-7	7-10	10-14
Vespel			
PEEK			
Tefzel			

Valve Parts

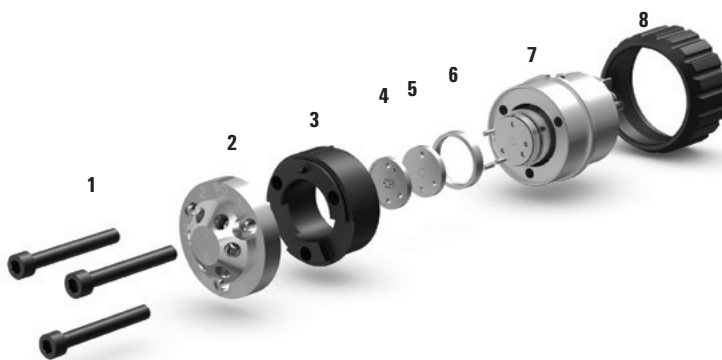

1. **Stator screws**
2. **Stator head** – Supported port size depends on the valve type
3. **Stator face seal** – Only used on some valves
4. **Stator ring** – Not available for all valves
5. **Rotor seal** – Alternatives in rotor seal material only available as listed in the tables
6. **Bearing ring / isolation seal** – Bearing ring for all Quick Change valve heads (p/n 1535-4045)
7. **Valve body** – No maintainable parts
8. **Spanner nut** – (p/n 5068-0106)



InfinityLab Quick Change Valve and Switching Valve Supplies

A set of valve types specially designed for Agilent HPLC systems allows you to extend your HPLC applications. New valve offerings give you:

- More flexibility in solvent selection and column selection
- New automation capabilities in sample preparation
- Increased sample throughput through alternating column regeneration
- Increased separation performance with multidimensional chromatography

Column Switching Valves Replacement Parts (G1316A/G1316B)

Description	Use With	Rotor Seal Material	Rotor Seal	Stator Face	Stator Head	Bearing Ring	Repair Kit
2 position/6 port, 400 bar	G1316A/B	Tefzel	0100-1854	0100-1851	0100-1850	0100-1852	0101-1258
		Vespel	0100-1855				
		PEEK	0100-2233				
2 position/10 port column switching valve, 400 bar	G1316A	PEEK	Repair kit	Repair kit	0101-1362	0100-1852	0101-1360
2 position/6 port HP column switching valve, 600 bar	G1316A 1260 Series/ G1316B	PEEK	0101-1409		0101-1417	1535-4045	
2 position/6 port micro column switching valve, 400 bar	G1316A	Vespel	0100-2087		0100-2089		



Stator for 2 position/6 port switching valve, 600 bar,
0101-1417



Rotor seal, 2 position/6 port, 600 bar,
for G1316B, 0101-1409

InfinityLab Quick Change Valve Supplies

Quick Change valve heads can be used with G1316C, G1170A, G4227A, G7116A/B modules

Description	Rotor Seal	Stator Head	Port Size	Stator Ring	Stator Face	Comments
2 Position Switching Valves						
2 position/6 port valve head, 600 bar (p/n 5067-4137)	0101-1409	0101-1417	10-32	5068-0120		
2 position/6 port valve head, 1200 bar (p/n 5067-4117)	5068-0008	5068-0006	10-32	5068-0120		
2 position/6 port valve head, 1300 bar (p/n 5067-4241)	5068-0207	5068-0006	10-32	5068-0120		G7116B
2 position/10 port micro valve head, 600 bar (p/n 5067-4144)	0101-1415	0101-1421	M4	-		
2 position/10 port valve head, 600 bar (p/n 5067-4145)	0101-1415	5068-0165	10-32	-		
2 position/10 port valve head, 1200 bar (p/n 5067-4118)	5068-0012	5068-0011	10-32	-		
2 position/10 port valve head, 1300 bar (p/n 5067-4240)	5068-0205	5068-0206	10-32	-		G7116B
2 position/10 port valve head, 600 bar, preparative scale (p/n 5067-4193)	5068-0153	5068-0152	10-32	-		
2 position/6 port valve head, 800 bar (p/n 5067-4282)	0101-1409	0101-1417	10-32	-		
2 position/10 port valve head, 800 bar (p/n 5067-4283)	0101-1415	5068-0165	10-32	-		
Multi-position Selection Valves						
6-column selector valve head, 600 bar (p/n 5067-4146)	5068-0076	5068-0077	M4	-		
6-column selector valve head, 800 bar (p/n 5067-4284)	5068-0298	5068-0241	M4			
6-column selector valve head, 1200 bar (p/n 5067-4142)	5068-0067	5068-0077	M4	-		
6-column selector valve head, 1300 bar (p/n 5067-4273)	5068-0242	5068-0241	M4			G7116B
4-column selector valve head, 600 bar (p/n 5067-4287)	5068-0264	5068-0263	M4	-		G7116A/B
4-column selector valve head, 800 bar (p/n 5067-4279)	5068-0264	5068-0263	M4			
8-column selector valve head, 1300 bar (p/n 5067-4233)	5068-0200	5068-0199	M4	-		G7116B
8 position/9 port valve head, 600 bar (p/n 5067-4107)	5067-4111	5068-0001	10-32	5068-0120		
8 position/9 port valve head, 1200 bar (p/n 5067-4121)	5068-0002	5068-0001	10-32	5068-0120		
8 position/9 port valve head, 600 bar, preparative scale (p/n 5067-4194)	5068-0155	5068-0154	10-32	5068-0120		

(Continued)



Valve head, 2 position/6 port,
600 bar, 5067-4137



6-Column selector valve head,
1200 bar, 5067-4142 on G1170A
1290 Infinity Valve Drive



Valve head 8 position/18port 1300 bar,
5067-4233

TCC/MCT AND VALVE SUPPLIES

InfinityLab Quick Change Valve Supplies

Quick Change valve heads can be used with G1316C, G1170A, G4227A, G7116A/B modules

Description	Rotor Seal	Stator Head	Port Size	Stator Ring	Stator Face	Comments
Special Solution Valves						
2D-LC valve head, 1200 bar	5068-0186	5068-0115	10-32	5068-0120		
2D-LC valve head, 1300 bar	5068-0214	5068-0115	10-32	-		Bearing ring p/n 1535-4045
2D-LC active flow modulation valve, 1300 bar	5068-0240	5068-0239	10-32/M4	-		Bearing ring NA
Stream selector valve, 600 bar	5068-0183	5068-0124	10-32	-		
Stream selector valve, 1200 bar	5068-0125	5068-0124	10-32	-		
Bio-inert Valves						
2 position/6 port valve head, 600 bar, bio-inert (p/n 5067-4148)	0101-1409	5068-0060	10-32	5068-0120	0100-1851	
2 position/10 port valve head, 600 bar, bio-inert (p/n 5067-4132)	5068-0041	5068-0040	10-32	-	5068-0095	
4-column selector valve head, 600 bar, bio-inert (p/n 5067-4134)	5068-0045	5068-0044	10-32	-	5068-0093	
12 position/13 port bio-inert solvent selector valve head, 200 bar (p/n 5067-4159)	0101-1288	5068-0097	10-32	-	0101-1288	

Note: Bearing ring for all Quick Change valve heads, p/n 1534-4045

Information on the valve supported fitting type

Key	Description
M4	Metric M4 (M) fittings
10-32	Supports standard Swagelok fittings, for example: S, SL, SX, and Quick Turn

Column Switching Valves and Capillary Kits

Valve Type	Supported Fitting Type	Available Capillary Kits	Part No.
For G1316A/B Thermostatted Column Compartment			
2 position/6 port column switching valve	10-32	Capillary kit, 0.17 mm id, 2 position/6 port, G1316C	5067-4730
2 position/10 port column regeneration valve			
For G1316C Thermostatted Column Compartment			
2 position/6 port valve head	10-32	Capillary kit, 0.12 mm id, 2 position/6 port, with low dispersion heat exchanger double	5067-4250
		Capillary kit, 0.17 mm id, 2 position/6 port, G1316C	5067-4730
2 position/10 port micro valve head	M4	Capillary kit, 0.12 mm id, 2 position/10 port, G1316C, micro valve	5067-4800
		Capillary kit, 0.17 mm id, 2 position/10 port, G1316C, micro valve	5067-5103
2 position/10 port valve head	10-32	Capillary kit, 0.12 mm id, 2 position/10 port, with low dispersion heat exchanger double	5067-4252
		Capillary kit, 0.17 mm id, 2 position/6 port, G1316C	5067-4730
2 position/10 port valve head, preparative scale	10-32	No kit available	
6-Column selector valve head	M4	Capillary kit, 0.17 mm id, 6 position/14 port valve	5067-4234
		Capillary kit, 0.12 mm id, 6-Column selector, G1316C	5067-6187
2 position/6 port valve head, bio-inert	10-32	Capillary kit, 0.17 mm id, 2 position/6 port, 600 bar, bio-inert	5067-4767
2 position/10 port valve head, bio-inert	10-32	Capillary kit, 0.17 mm id, 2 position/10 port, 600 bar, bio-inert	5067-5419
4-Column selector valve head, bio-inert	10-32	Capillary kit, 0.17 mm id, 4-Column selector, 600 bar, bio-inert	5067-4769
For G7116A/B Multicolumn Thermostat			
2 position/6 port valve head	10-32	Capillary kit, 0.12 mm id, 2 position/6 port, with Quick-Connect heat exchanger	5067-4249
		Capillary kit, 0.17 mm id, 2 position/6 port, with Quick-Connect heat exchanger	5067-6597
2 position/10 port valve head	10-32	Capillary kit, 0.12 mm id, 2 position/10 port, with Quick-Connect heat exchanger	5067-4251
		Capillary kit, 0.17 mm id, 2 position/10 port, with Quick-Connect heat exchanger	5067-6598
4-column selector valve head	M4	Capillary kit, 0.12 mm id, 4-column, with Quick-Connect heat exchanger	5067-6596
		Capillary kit, 0.17 mm id, 4-column, with Quick-Connect heat exchanger	5067-4300
6-Column selector valve head (G7116B)	M4	Capillary kit, 0.12 mm id, 6-column selector, with Quick-Connect heat exchanger	5067-4270
8-Column selector valve head (G7116B)	M4	Capillary kit, 0.12 mm id, 8-column selector, with Quick-Connect heat exchanger	5067-4248
2 position/6 port valve head, bio-inert	10-32	Capillary kit, 0.17 mm id, 2 position/6 port, 600 bar, bio-inert	5067-4767
2 position/10 port valve head, bio-inert	10-32	Capillary kit, 0.17 mm id, 2 position/10 port, 600 bar, bio-inert	5067-5419
4-Column selector valve head, bio-inert	10-32	Capillary kit, 0.17 mm id, 4-Column selector, 600 bar, bio-inert	5067-4769
G1170A Infinity Valve Drive			
2 position/6 port valve head	10-32	Capillary kit, 0.17 mm id, for column selection with ICC in G7129A/B	5067-6707
		Capillary kit, 0.12 mm id, for column selection with ICC in G7129A/B	5067-6706

Information on the valve supported fitting type

Key	Description
M4	Metric M4 (M) fittings
10-32	Supports standard Swagelok fittings, for example: S, SL, SX, and Quick Turn

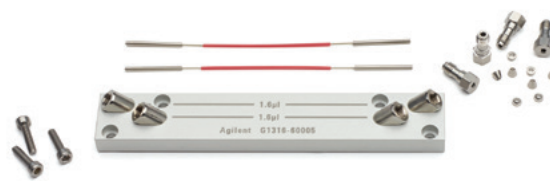

Low dispersion heat exchanger double kit for G1316B/C, G1316-80022

Capillary Kit Contents

Capillary Kit Contents

Description	Quantity	Connection	Part No.	Replacement Part*
Capillary kit, 0.12 mm, 2 position/6 port valve, LDHE double, G1316C			5067-4250	
LD-precolum heat exchanger double-assembly	1		G1316-80022	
Capillary, stainless steel, 0.12 x 340 mm, S/SX	1	Autosampler to valve	5067-4647	
Capillary, stainless steel, 0.17 x 700 mm, S/SX	1	Pump to valve (automatted column regeneration)	5067-4648	
Capillary, stainless steel, 0.12 x 90 mm, S/SX	2	Valve to heat exchanger	5067-4649	
Capillary, stainless steel, 0.12 x 150 mm, SL/SX	2	Short column to valve	5067-4650	
Capillary, stainless steel, 0.12 x 280 mm, SL/SX	2	Long column to valve	5067-4651	
Capillary, stainless steel, 0.12 x 120 mm, SX/SX	1	Valve to valve (bypass)	5067-4652	
Capillary, stainless steel, 0.12 x 200 mm, S/SX	1	Valve to detector	5067-4653	
Fitting, male PEEK, 2/pk	1	Waste line	0100-1516	
Tube, PTFE, 2 m	1	Valve to waste	0890-1713	5062-2462 (5 m)
Column clip set, eight colors	1		5042-9918	
Capillary kit, 0.17 mm, 2 position/10 port valve, G1316C			5067-4730	
Capillary, stainless steel, 0.17 x 700 mm, S/SX	1	Pump to valve (automatted column regeneration)	5067-4648	
Capillary, stainless steel, 0.17 x 120 mm, SX/SX	1	Valve to valve (bypass)	5067-4719	
Capillary, stainless steel, 0.17 x 150 mm, SL/SX	2	Short column to valve	5067-4720	
Capillary, stainless steel, 0.17 x 200 mm, S/SX	1	Valve to detector	5067-4721	
Capillary, stainless steel, 0.17 x 280 mm, SL/SX	2	Long column to valve	5067-4722	
Capillary, stainless steel, 0.17 x 340 mm, S/SX	1	Autosampler to valve	5067-4723	
Capillary, stainless steel, 0.17 x 90 mm, S/SX	4	Valve to heat exchanger and heat exchanger to column	5067-4724	
Column clip set, eight colors	1		5042-9918	
Tube, PTFE, 2 m	1	Valve to waste	0890-1713	5062-2462 (5 m)

(Continued)

Fitting Left/Fitting Right			
Key	Description	Key	Description
W	Swagelok + 0.8 mm port id	H	Long head
S	Swagelok + 1.6 mm port id	G	Small head SW 4 mm
M	Metric M4 + 0.8 mm port id	N	Small head SW 5 mm
E	Metric M3 + 1.6 mm port id	F	Finger-tight
U	Female Swagelok union	V	1200 bar
L	Long	B	Bio
X	Extra long	P	PEEK

Capillary Kit Contents

Description	Quantity	Connection	Part No.	Replacement Part*
Capillary kit, 0.12 mm, 2 position/10 port micro valve, G1316C			5067-4800	
Capillary, stainless steel, 0.12 x 340 mm, SL/M	1	Autosampler to valve	5067-4744	
Capillary, stainless steel, 0.17 x 700 mm, SL/M	1	Pump to valve (automatted column regeneration)	5067-5120	
Capillary, stainless steel, 0.12 x 90 mm, SL/M	2	Valve to heat exchanger	5067-5106	
Capillary, stainless steel, 0.12 x 150 mm, SV/M	2	Short column to valve	5067-5104	
Capillary, stainless steel, 0.12 x 280 mm, SV/M	1	Long column to valve	5067-5107	
Capillary, stainless steel, 0.17 x 150 mm, M/M	1	Valve to valve (bypass)	5067-4737	
Capillary, stainless steel, 0.12 x 250 mm, SV/M	1	Valve to detector	5067-4746	
Tubing, PEEK, 0.03 inch od, 0.4 mm id, 450 mm	2	Waste line	5022-6503	
Fitting, PEEK	2	Valve to waste/waste line	G4240-43200 (x 2)	
Column clip set, eight colors	1		5042-9918	
Fitting holder assembly	2		G1316-68706 (x 2)	
Heat exchanger, long-up, 1.6 µL	1		G1316-80002	
Heat exchanger, long-down, 1.6 µL	1		G1316-80003	
Carrier for heat exchanger TCC SL Plus	1		G1316-89200 (x 2)	
Capillary kit, 0.17 mm, 2 position/10 port micro valve, G1316C			5067-5103	
Capillary, stainless steel, 0.17 x 340 mm, SL/M	1	Autosampler to valve	5067-5108	
Capillary, stainless steel, 0.17 x 700 mm, SL/M	1	Pump to valve (automatted column regeneration)	5067-5120	
Capillary, stainless steel, 0.17 x 90 mm, SL/M	2	Valve to heat exchanger	5067-5109	
Capillary, stainless steel, 0.17 x 90 mm, SV/M	2	Heat exchanger to column	5067-5110	
Capillary, stainless steel, 0.17 x 150 mm, SV/M	2	Short column to valve	5067-5111	
Capillary, stainless steel, 0.17 x 280 mm, SV/M	2	Long column to valve	5067-5112	
Capillary, stainless steel, 0.17 x 150 mm, M/M	1	Valve to valve (bypass)	5067-4737	
Capillary, stainless steel, 0.17 x 250 mm, SL/M	1	Valve to detector	5067-5113	
Tubing, PEEK, 0.03 inch od, 0.4 mm id, 450 mm	2	Valve to waste	5022-6503	
Fitting, PEEK	1		G4240-43200 (x 2)	
Column clip set, eight colors	1		5042-9918	

(Continued)

Fitting Left/Fitting Right			
Key	Description	Key	Description
W	Swagelok + 0.8 mm port id	H	Long head
S	Swagelok + 1.6 mm port id	G	Small head SW 4 mm
M	Metric M4 + 0.8 mm port id	N	Small head SW 5 mm
E	Metric M3 + 1.6 mm port id	F	Finger-tight
U	Female Swagelok union	V	1200 bar
L	Long	B	Bio
X	Extra long	P	PEEK

Capillary Kit Contents

Description	Quantity	Connection	Part No.	Replacement Part*
Capillary kit, 0.12 mm, 2 position/10 port valve, LDHE double, G1316C			5067-4252	
Capillary, stainless steel, 0.12 x 340 mm, S/SX	1	Autosampler to valve	5067-4684	
Capillary, stainless steel, 0.17 x 700 mm, S/SX	1	Pump to valve (automatted column regeneration)	5067-4648	
Capillary, stainless steel, 0.12 x 90 mm, S/SX	2	Valve to heat exchanger	5067-4685	
Capillary, stainless steel, 0.12 x 150 mm, SX/SX	2	Short column to valve	5067-4686	
Capillary, stainless steel, 0.12 x 280 mm, SX/SX	2	Long column to valve	5067-4687	
Capillary, stainless steel, 0.12 x 120 mm, SX/SX	1	Valve to valve (bypass)	5067-4688	
Capillary, stainless steel, 0.12 x 200 mm, S/SX	1	Valve to detector	5067-4689	
Fitting, male, PEEK, 2/pk	1		0100-1516	
Tube, PTFE, 2 m	1	Valve to waste	0890-1713	5062-2462 (5 m)
Column clip set, eight colors	1		5042-9918	
Capillary kit, 0.17 mm, 6-column selector valve, LDHE double, G1316C			5067-4234	
Capillary, stainless steel, 0.17 x 340 mm, SL/M	1	Autosampler to TCC heater	5067-5108	
Capillary, stainless steel, 0.17 x 250 mm, SL/M	2	Heater to valve, valve to detector	5067-5113	
Capillary, stainless steel, 0.17 x 280 mm, SV/M	4	Valve to column	5067-5112	
Capillary, stainless steel, 0.17 x 150 mm, SV/M	4	Column to valve	5067-5111	
Capillary, stainless steel, 0.17 x 150 mm, M/M	1	Valve to valve (bypass)	5067-4737	
Waste tube	1		G1375-87326	
Hex driver, SW-4, slitted	1		5023-2504	
Column clip set, eight colors	1		5042-9918	
M4 blank nut	2		5067-6141	

(Continued)

Fitting Left/Fitting Right			
Key	Description	Key	Description
W	Swagelok + 0.8 mm port id	H	Long head
S	Swagelok + 1.6 mm port id	G	Small head SW 4 mm
M	Metric M4 + 0.8 mm port id	N	Small head SW 5 mm
E	Metric M3 + 1.6 mm port id	F	Finger-tight
U	Female Swagelok union	V	1200 bar
L	Long	B	Bio
X	Extra long	P	PEEK

Capillary Kit Contents

Description	Quantity	Connection	Part No.	Replacement Part*
Capillary kit, 0.12 mm, 6-column selector valve, LDHE double, G1316C			5067-6187	
LD-Precolumn heatexchanger double assembly	2		G1316-80022	
Capillary, stainless steel, 0.12 x 130 mm, M4 PS-NS LS	8	Valve to heat exchanger, column to valve	5500-1200	
Capillary, stainless steel, 0.17 x 150 mm, M/M	1	Valve to valve (bypass)	5067-4737	
Capillary, stainless steel, 0.12 x 340 mm, SL/M	1	Autosampler to valve	5067-4744	
Capillary, stainless steel, 0.12 x 500 mm, M4-SL PS-PS	1	Autosampler (dual stack) to valve	5500-1202	
Capillary, stainless steel, 0.12 x 280 mm, M4-SL PS-PS	1	Valve to detector	5500-1203	
Column clip set, eight colors	1		5042-9918	
Hex driver, SW-4, slitted	1		5023-2504	
Waste tube	1		G1375-87326	
M4 blank nut	2		5067-6141	
Capillary kit, 0.17 mm, 2 position/6 ports, 600 bar, bio-inert, G1316C, G7116A/B			5067-4767	
Capillary, PEEK/stainless steel, 0.17 x 400 mm, RLO/RLO, bio-inert	1	Sampler to valve	G5667-81004	
Capillary, PEEK/stainless steel, 0.17 x 300 mm, RLO/RLO, bio-inert	2	Valve to column	G5667-81003	
Tubing, PEEK, 1.6 mm od, 0.18 mm id, 1.5 m	1		0890-1763	
Fitting holder assembly	2		G1316-68706	
Fingertight fitting, long	1		5062-8541	
Column holder clips (lamella type), 2/pk	1		G7116-68003	
Tubing, flex, 2 m	1		0890-1713	5062-2462 (5 m)
Plastic fittings	4		0100-1259	

(Continued)

Fitting Left/Fitting Right			
Key	Description	Key	Description
W	Swagelok + 0.8 mm port id	H	Long head
S	Swagelok + 1.6 mm port id	G	Small head SW 4 mm
M	Metric M4 + 0.8 mm port id	N	Small head SW 5 mm
E	Metric M3 + 1.6 mm port id	F	Finger-tight
U	Female Swagelok union	V	1200 bar
L	Long	B	Bio
X	Extra long	P	PEEK

Capillary Kit Contents

Description	Quantity	Connection	Part No.	Replacement Part*
Capillary kit, 0.17 mm, 2 position/10 ports, 600 bar, bio-inert, G1316C, G7116A/B			5067-5419	
Capillary, titanium, 700 x 0.17 mm id	1	Regeneration pump to the valve	G5611-60501	
Capillary, PEEK/stainless steel, 0.17 x 300 mm, RLO/RLO, bio-inert	2	Valve to column inlet	G5667-81003	
Capillary, PEEK/stainless steel, 0.17 x 400 mm, RLO/RLO, bio-inert	1	Valve outlet to detector	G5667-81004	
Tubing, flex, 2 m	1	Valve to waste	0890-1713	5062-2462 (5 m)
Capillary, PEEK, 0.18 mm id, 1.5 m	1		0890-1763	
Column holder clips (lamella type), 2/pk	1		G7116-68003	
Capillary kit, 0.17 mm, 4 column selector, 600 bar, bio-inert, G1316C, G7116A/B			5067-4769	
Capillary, PEEK/stainless steel, 0.17 x 300 mm, RLO/RLO, bio-inert	2	Valve to column inlet	G5667-81003	
Capillary, PEEK/stainless steel, 0.17 x 400 mm, RLO/RLO, bio-inert	1	Sampler to Valve	G5667-81004	
Capillary, PEEK, 0.18 mm id, 1.5 m	1		0890-1763	
Column holder clips (lamella type) 2/pk	1		G7116-68003	
Fitting holder assembly	2		G1316-68706	
Fingertight fitting, long	1		5062-8541	
Column holder clips (lamella type), 2/pk	1		G7116-68003	
Capillary kit, 0.12 mm, 2 position/6 port valve, QCHE, G7116B			5067-4249	
Heat exchanger assembly, 1.6 µL-Z	1		G7116-60015	
InfinityLab Quick Connect assembly, stainless steel, 0.12 x 105 mm	1	Heat exchanger to column	5067-5957	
Capillary, stainless steel, 0.12 x 90 mm, S/SX	2	Valve to heat exchanger	5067-4649	
Capillary, stainless steel, 0.12 x 150 mm	2	Column (short) to valve	5500-1189	
Capillary, stainless steel, 0.12 x 280 mm	2	Column (long) to valve	5500-1191	
Capillary, stainless steel, 0.12 x 200 mm, S/SX	2	Valve to detector	5500-1209	5500-1190 (without fittings)
Tubing, flex, 2 m	1	Valve to waste	0890-1713	5062-2462 (5 m)
Column holder clips (lamella type) 2/pk	1		G7116-68003	

(Continued)

Fitting Left/Fitting Right			
Key	Description	Key	Description
W	Swagelok + 0.8 mm port id	H	Long head
S	Swagelok + 1.6 mm port id	G	Small head SW 4 mm
M	Metric M4 + 0.8 mm port id	N	Small head SW 5 mm
E	Metric M3 + 1.6 mm port id	F	Finger-tight
U	Female Swagelok union	V	1200 bar
L	Long	B	Bio
X	Extra long	P	PEEK

Capillary Kit Contents

Description	Quantity	Connection	Part No.	Replacement Part*
Capillary kit, 0.17 mm, 2 position/6 port valve, QCHE, G7116B			5067-6597	
Heat exchanger assembly, 1.6 μ L-Z	1		G7116-60015	
Capillary, stainless steel, 0.17 x 105 mm, long socket	4	Heat exchanger to column, valve to heat exchanger	5500-1193	
Capillary, stainless steel, 0.12 x 150 mm, long socket	2	Column (short) to valve	5500-1189	
Capillary, stainless steel, 0.12 x 280 mm, long socket	2	Column (long) to valve	5500-1191	
Fittings, PEEK, 2/pk	3	Column outlet	0100-1516	
Stainless steel long fittings, 10/pk	1		5065-4454	
Capillary, stainless steel, 0.12 x 280 mm, long socket	1	Valve to detector	5500-1191	
Capillary kit, 0.12 mm, 2 position/10 port valve, QCHE, G7116B			5067-4251	
Heat exchanger assembly, 1.6 μ L-Z	1		G7116-60015	
InfinityLab Quick Connect assembly, stainless steel, 0.12 x 105 mm	1	Heat exchanger to column	5067-5957	
Capillary, stainless steel, 0.12 x 150 mm	2	Column (short) to valve	5500-1189	
Capillary, stainless steel, 0.12 x 280 mm	2	Column (long) to valve	5500-1191	
Capillary, stainless steel, 0.12 x 120 mm, SX/SX	1	Valve to valve bypass line	5067-4688	
Capillary, stainless steel, 0.12 x 200 mm, SX/S	1	Valve to detector	5500-1209	5500-1190 (without fittings)
Capillary, stainless steel, 0.12 x 500 mm, SX/SX	1	ALS to valve	5500-1210	5500-1192 (without fittings)
Capillary, stainless steel, 0.17 x 700 mm, S/SX	1	Pump to valve	5067-4648	
Capillary, stainless steel, 0.12 x 90 mm, S/SX	2	Valve to heat exchanger	5067-4685	
Tube, PTFE, 2 m	1	Waste line	0890-1713	5062-2462 (5 m)
Column holder clips (lamella type), 2/pk	2		G7116-68003	

(Continued)

Fitting Left/Fitting Right			
Key	Description	Key	Description
W	Swagelok + 0.8 mm port id	H	Long head
S	Swagelok + 1.6 mm port id	G	Small head SW 4 mm
M	Metric M4 + 0.8 mm port id	N	Small head SW 5 mm
E	Metric M3 + 1.6 mm port id	F	Finger-tight
U	Female Swagelok union	V	1200 bar
L	Long	B	Bio
X	Extra long	P	PEEK

Capillary Kit Contents

Description	Quantity	Connection	Part No.	Replacement Part*
Capillary kit, 0.17 mm, 2 position/10 port valve, QCHE, G7116B			5067-6598	
Heat exchanger assembly, 1.6 µL-Z	1		G7116-60015	
Capillary, stainless steel, 0.17 x 105 mm	4	Heat exchanger to column, valve to heat exchanger	5500-1193	
Capillary, stainless steel, 0.12 x 150 mm	2	Column (short) to valve	5500-1189	
Capillary, stainless steel, 0.12 x 280 mm	2	Long column to valve	5500-1191	
Capillary, stainless steel, 0.17 x 120 mm, SL-SL	1	Bypass	5067-4719	
Fittings, PEEK, 2/pk	3	Column outlet	0100-1516	
Long fittings, stainless steel, 10/pk	1		5065-4454	
Capillary, stainless steel, 0.12 x 280 mm	1	Valve to detector	5500-1191	
Tube, PTFE, 2 m	1	Waste line	0890-1713	5062-2462 (5 m)
Column holder clips (lamella type), 2/pk	2		G7116-68003	
Capillary kit, 0.12 mm id, 6-column selector, QCHE, G7116B			5067-4270	
Heat exchanger assembly, 1.6 µL-Z	6		G7116-60015	
Capillary, stainless steel, 0.12 x 105 mm, SL PS-LS	6	Heat exchanger to column	5500-1201	
Capillary, stainless steel, 0.12 x 130 mm, M4-SL PS-PS	6	Valve to heat exchanger	5500-1199	
Capillary, stainless steel, 0.12 x 130 mm, M4 PS-NS LS	6	Column to valve	5500-1200	
Fittings, PEEK, 10/pk	1	Column outlet fitting	5063-6591	
Capillary, stainless steel, 0.12 x 500 mm, M4-SL PS-PS	1	Autosampler to valve	5500-1202	
Capillary, stainless steel, 0.12 x 280 mm, M4-SL PS-PS	1	Valve to detector	5500-1203	
Capillary, stainless steel, 0.12 x 150 mm, M4-M4 PS-PS	1	Valve to valve (bypass)	5500-1204	
Waste tube, including fitting	1		G1375-87326	
M4 blank nut	2		5067-6141	
Column holder clamp, for Infinity II, 2/pk	6		G7116-68004	

(Continued)

Fitting Left/Fitting Right			
Key	Description	Key	Description
W	Swagelok + 0.8 mm port id	H	Long head
S	Swagelok + 1.6 mm port id	G	Small head SW 4 mm
M	Metric M4 + 0.8 mm port id	N	Small head SW 5 mm
E	Metric M3 + 1.6 mm port id	F	Finger-tight
U	Female Swagelok union	V	1200 bar
L	Long	B	Bio
X	Extra long	P	PEEK

Capillary Kit Contents

Description	Quantity	Connection	Part No.	Replacement Part*
Capillary kit, 0.12 mm, 8-column selector, QCHE, G7116B			5067-4248	
Heat exchanger assembly, 1.6 µL-Z	8		G7116-60015	
Capillary, stainless steel, 0.12 x 500 mm, M4-SL PS-PS	1	Autosampler to valve	5500-1202	
Capillary, stainless steel, 0.12 x 130 mm, M4-SL PS-PS	8	Valve to heat exchanger	5500-1199	
Capillary, stainless steel, 0.12 x 130 mm, M4 P S-NS LS	8	Column to valve	5500-1200	
Fittings, PEEK, 10/pk	1	Column outlet	5063-6591	
Capillary, stainless steel, 0.12 x 105 mm, SL PS-LS	8	Heat exchanger (PS-SL) to column	5500-1201	
Capillary, stainless steel, 0.12 x 280 mm, M4-SL PS-PS	1	Valve to detector	5500-1203	
Capillary, stainless steel, 0.12 x 150 mm, M4-M4 PS-PS	1	Valve to valve (column bypass)	5500-1204	
Waste tube, including M4 PEEK fitting	1		G1375-87326	
M4 Blank nut	3		5067-6141	
Column holder clips (lamella type), 2/pk	8		G7116-68003	
Hex driver, SW-4 slitted	1	Tool for M4 fittings	5023-2504	
Capillary kit, 0.12 mm, 4-column selector, QCHE, G7116A			5067-6596	
Heat exchanger assembly, 1.6 µL-Z	4		G7116-60015	
Capillary, stainless steel, 0.12 x 500 mm, M4-SL PS-PS	1	Autosampler to valve	5500-1202	
Capillary, stainless steel, 0.12 x 130 mm, M4-SL PS-PS	4	Valve to heat exchanger	5500-1199	
Capillary, stainless steel, 0.12 x 130 mm, M4 PS-NS LS	4	Column to valve	5500-1200	
Fittings, PEEK, 10/pk	1	Column outlet	5063-6591	
Capillary, stainless steel, 0.12 x 105 mm, SL PS-LS	4	Heat exchanger (PS-SL) to column	5500-1201	
Capillary, stainless steel, 0.12 x 280 mm, M4-SL PS-PS	1	Valve to detector	5500-1203	

(Continued)

Fitting Left/Fitting Right			
Key	Description	Key	Description
W	Swagelok + 0.8 mm port id	H	Long head
S	Swagelok + 1.6 mm port id	G	Small head SW 4 mm
M	Metric M4 + 0.8 mm port id	N	Small head SW 5 mm
E	Metric M3 + 1.6 mm port id	F	Finger-tight
U	Female Swagelok union	V	1200 bar
L	Long	B	Bio
X	Extra long	P	PEEK

Capillary Kit Contents

Description	Quantity	Connection	Part No.	Replacement Part*
Capillary, stainless steel, 0.12 x 150 mm, M4-M4 PS-PS	1	Valve to valve (column bypass)	5500-1204	
Waste tube, including M4 PEEK fitting	1		G1375-87326	
M4 blank nut	3		5067-6141	
Column holder clips (lamella type), 2/pk	1		G7116-68003	
Hex driver SW-4 slitted	1	Tool for M4 fittings	5023-2504	
Capillary kit, 0.17 mm, 4-column selector, QCHE, G7116A			5067-4300	
Heat exchanger assembly, 1.6 µL-Z	4		G7116-60051	
Column holder clips (lamella type) 2/pk	4		G7116-68003	
Capillary, stainless steel, 0.17 mm x 500 mm, SL-M4 PS-PS	1	Autosampler to valve	5067-6188	
Capillary, stainless steel, 0.17 mm x 90 mm, SL/M	4	Valve to heat exchanger	5067-5109	
Capillary, stainless steel, 0.12 mm x 250 mm, SV/M	4	Long column to valve	5067-4746	
Capillary, stainless steel, 0.12 mm x 130 mm, SL/M	4	Short column to valve	5500-1200	
Fitting, male, PEEK, 2/pk	2	Column outlet	0100-1516	
Fitting, stainless steel, long, SL	4		G1314-68703	5065-4454 (10/pk)
Capillary, stainless steel, 0.17 mm x 105 mm	4	Heat exchanger to column	5500-1193	
Capillary, stainless steel, 0.12 mm x 280 mm, M4-SL PS-PS	1	Valve to detector	5500-1203	
Capillary, stainless steel, 0.12 mm x 150 mm, M4-M4 PS-PS	1	Valve to valve (column bypass)	5500-1204	
Fitting screw, long, 10/pk	1		5065-4454	
Hex driver, SW-4 slitted	1	Tool for M4 fittings	5023-2504	
M4 blank nut	3		5067-6141	
Waste tube, including M4 PEEK fitting	1		G1375-87326	

(Continued)

Fitting Left/Fitting Right			
Key	Description	Key	Description
W	Swagelok + 0.8 mm port id	H	Long head
S	Swagelok + 1.6 mm port id	G	Small head SW 4 mm
M	Metric M4 + 0.8 mm port id	N	Small head SW 5 mm
E	Metric M3 + 1.6 mm port id	F	Finger-tight
U	Female Swagelok union	V	1200 bar
L	Long	B	Bio
X	Extra long	P	PEEK

Capillary Kit Contents

Description	Quantity	Connection	Part No.	Replacement Part*
Capillary kit, 0.17 mm column select** ICC, 2 position/6 port valve, G1170A			5067-6707	
Capillary, stainless steel, 0.17 mm x 400 mm, long socket	3	Viialsampler to valve (x 1), valve to ICC (x 2)	5500-1236	
Quick Connect fitting assembly, 0.17 mm x 105 mm	2	ICC to column	5067-6166	
Capillary, stainless steel, 0.12 x 500 mm, long socket	2	Column to valve	5500-1192	
Quick Turn fitting	2	Column outlet	5067-5966	
Capillary, stainless steel, 0.12 x 400 mm, SL/SL long socket	1	Valve to detector	5500-1251	
Long fittings and ferrules, stainless steel, 10/pk	1		5065-4454	
Capillary kit, 0.12 mm column select*** ICC, 2 position/6 port valve, G1170A			5067-6708	
Capillary, stainless steel, 0.17 x 400 mm, long socket	3	Viialsampler to valve (x 1), valve to ICC (x 2)	5500-1251	
Quick Connect fitting assembly, 0.17 x 105 mm	2	ICC to column	5067-5957	
Capillary, stainless steel, 0.12 x 500 mm, long socket	2	Column to valve	5500-1192	
Quick Turn fitting	2	Column outlet	5067-5966	
Capillary, stainless steel, 0.12 x 400 mm, SL/SL, long socket	1	Valve to detector	5500-1251	
Long fittings and ferrules, stainless steel, 10/pk	1		5065-4454	

*Products with replacement parts are available as part of a kit, but are not available for individual purchase.

** Dual column selection for viialsampler and external 2 position/6 port valve

*** Dual column selection for viialsampler and external valve

Fitting Left/Fitting Right			
Key	Description	Key	Description
W	Swagelok + 0.8 mm port id	H	Long head
S	Swagelok + 1.6 mm port id	G	Small head SW 4 mm
M	Metric M4 + 0.8 mm port id	N	Small head SW 5 mm
E	Metric M3 + 1.6 mm port id	F	Finger-tight
U	Female Swagelok union	V	1200 bar
L	Long	B	Bio
X	Extra long	P	PEEK



7725i manual injection valve, 5063-6502

Manual Injection Valves

Agilent provides the latest developments in LC injection technology from Rheodyne.

- Continuous flow path with “Make-Before-Break” design
- Sample capacity
- Choice of stainless steel or PEEK flowpath
- Easy access to fittings due to wide 30 ° port angles

Series 7725i and 9725i Analytical Injection Valves

Stainless steel (SST) 7725i and PEEK 9725i valves are the most popular injection valves for analytical HPLC. Features include:

- A 20 μ L loop (installed). Loops are also available in stainless steel or PEEK from 5 μ L to 5 mL (10 mL for PEEK)
- Make-Before-Break (MBB) technology allows switching without flow interruption
- Wide 30° port angles offer easier access to fittings
- Built-in position sensing switch provides the chromatograph with a reproducible start signal

Series 3725i-038 and 3725i Preparative Injection Valves

The series 3725i-038 (stainless steel) and 3725i (PEEK) are the most suitable manual valves for large sample volumes, high flow rates, and preparative columns sized 1.0-10 cm in diameter.

- Versatile ports accommodate 1/8 inch (3.2 mm) and 1/16 inch (1.6 mm) od tubing.
Note: 1/16 inch od tubing requires an adapter, p/n 5067-1503
- 1.0 mm diameter passages allow flow rates up to 800 mL/min with virtually no pressure drop
- Make-Before-Break technology allows switching without flow interruption
- High reproducibility for both partial-filling and complete-filling methods
- Sample range is 100 μ L to 20 mL (10 mL loop is installed)
- Flow range is 10 to 800 mL/min
- Built-in position sensing switch gives the chromatograph a reproducible start signal

Manual Injection Valves with Position Sensing Switches

Description	Comments	Part No.	Rotor Seal Material	Rotor Seal	Stator Face	Stator Head	Bearing Ring	Isolation Seal	Repair Kit	Needle Port Adaptor
2 position/ 6 port valve, 400 bar (7725i)	Analytical, G1328A/B	5063-6502	Tefzel	0101-0620	0100-1859	0100-1860	1535-4045	1535-4046	0101-1254	
			Vespel	0101-0623						
			PEEK	0101-1255						
2 position/ 6 port valve, 600 bar (7725i)	Analytical, G1328C	5067-4191	PEEK	5068-0052	0100-1859	5068-0053	1535-4045	1535-4046	0100-1859	0100-1859
Manual injection valve, 400 bar (7725i), for 1120/1220	1120		PEEK	5067-4105		0100-1850				5067-1581
Manual injection valve, 600 bar (7725i)	Analytical for 1220 Infinity LC	5067-4202	PEEK	5068-0082		0101-1417	1535-4045			5067-1581
Bio-inert 2 position/ 6 port manual injection valve (9725i)	Analytical, Bio-inert	5067-4158	PEEK	5068-0082	0100-1851	5068-0060	1535-4045			5067-1581
Manual injection valve, 400 bar (9725i)	Analytical	0101-1253	Tefzel	0101-0620	0100-1859			1535-4046		
Manual prep injection valve, stainless steel (3725i)	Preparative	0101-1232	PEEK	0101-1233				1535-4046		
Manual prep injection valve, PEEK (7725i)	Preparative	0101-1231	PEEK	0101-1233				1535-4046		



Manual Injection Valve Replacement Parts

Manual Injection Valve Sample Loops

The right mix of injection valve sample loops are available for your application needs. Agilent offers factory-cut and finished loops of the highest quality.

- Rotor seals wear with use and need routine replacement
- Stators only need replacement if the ports are damaged
- PEEK rotor seals are incompatible with concentrated nitric and sulfuric acids
- Stainless steel loops are square cut and free of burrs for a flush connection
- Flexible PEEK loops have a clean, straight cut for low dead volume connections

Stainless Steel Sample Loops

- Sample loops for Rheodyne 7725 Series and 7125 Series valves are not interchangeable due to the change in port angle
- Actual volumes can differ due to tolerance of metal tubing bore
- Accuracy of large metal loops is $\pm 5\%$, intermediate loops $\pm 10\%$, and small loops $\pm 30\%$

PEEK Sample Loops

- Inert to most organic solvents
- Wall thickness, temperature, exposure time, and concentration of organic solvents affect the durability of PEEK tubing
- Concentrated nitric acid and sulfuric acid weaken PEEK tubing
- THF, methylene chloride, and DMSO cause PEEK to swell
- Actual volumes can differ because of tolerance of tubing bore
- Accuracy of large PEEK loops is $\pm 14\%$, intermediate loops $\pm 21\%$, and small loops $\pm 65\%$

Manual Injection Valve Sample Loops

The right mix of injection valve sample loops are available for your application needs. Agilent offers factory-cut and finished loops of the highest quality.

- Stainless steel loops are square cut and free of burrs for a flush connection
- Flexible PEEK loops have a clean, straight cut for low dead volume connections

Manual Injection Valve Sample Loops

Volume	id (mm)	Material	Use With	Part No.
5 μ L	0.18	Stainless steel	7125, 7010	1535-4860
	0.18	Stainless steel	7725	0101-1248
	0.18	PEEK	9725	0101-1241
10 μ L	0.30	Stainless steel	7125, 7010	0101-0376
	0.30	Stainless steel	7725	0100-1923
	0.25	PEEK	9725	0101-1240
20 μ L	0.51	Stainless steel	7125, 7010	0101-0377
	0.30	Stainless steel	7725	0100-1922
	0.25	PEEK	9725	0101-1239
50 μ L	0.51	Stainless steel	7125, 7010	0101-0378
	0.51	Stainless steel	7725	0100-1924
	0.51	PEEK	9725	0101-1238
100 μ L	0.51	Stainless steel	7125, 7010	0101-0379
	0.51	Stainless steel	7725	0100-1921
	0.51	PEEK	9725	0101-1242
200 μ L	0.76	Stainless steel	7125, 7010	0101-1252
	0.76	Stainless steel	7725	0101-1247
	0.51	PEEK	9725	0101-1237



Stainless steel sample loops

(Continued)



PEEK sample loops

Manual Injection Valve Sample Loops

Volume	id (mm)	Material	Use With	Part No.
500 μ L	0.76	Stainless steel	7125, 7010	0101-1251
	0.76	Stainless steel	7725	0101-1246
	0.76	PEEK	9725	0101-1236
1 mL	0.76	Stainless steel	7125, 7010	0101-1219
	0.76	Stainless steel	7725	0101-1245
	0.76	PEEK	9725	0101-1235
2 mL	1.00	Stainless steel	7125, 7010	0101-1250
	1.00	Stainless steel	7725	0101-1244
	0.76	PEEK	9725	0101-1234
	1.60	PEEK	3725	0101-1229
5 mL	1.00	Stainless steel	7125, 7010	0101-1249
	1.00	Stainless steel	7725	0101-1243
	0.76	PEEK	9725	0101-1230
	1.60	PEEK	3725	0101-1228
10 mL	2.00	PEEK	3725	0101-1227
20 mL	2.00	PEEK	3725	0101-1226

Real stories from the lab.

TRUE STORY NO. **17**
ASK THE EXPERT

A pharma lab in India was struggling to replicate a method transferred from a lab in the US. The CrossLab FSE helped them with a tip about their Agilent Infinity LC System.

Agilent
CrossLab
 From Insight to Outcome

www.agilent.com/chem/story17

Syringes for Manual Injection

Agilent color-coded manual syringes allow you to determine syringe volume with one quick glance, so you can more efficiently perform manual dilution, extraction, and sample preparation. They also give you the advantages of:

- Improved scale readability with a new vertical syringe scale orientation for more intuitive use
- A wide selection of volumes, making Agilent your “one-stop” resource for all of your sample manipulation needs
- Accuracy within $\pm 1\%$ of nominal volume, and precision within 1 %, measured at 80 % of total scale volume
- Environmentally friendly cardboard and plastic packaging that could be recycled to help reduce landfill waste
- A Certificate of Conformance to ensure the highest quality construction and performance, available for viewing and printing anytime
- Lot-traceable for accurate identification

Of course, all Agilent syringes are backed by over 40 years of chromatography expertise, industry-leading technical support, and a 90-day warranty from the date of shipment.



LC Manual Syringes with Fitted Plungers

Volume (μL)	Description	Unit	Needle	Part No.
5	Fixed	1/pk	22 gauge/2 inch/LC tip	5190-1480
10	Fixed	1/pk	22 gauge/2 inch/LC tip	5190-1484
	Removable	1/pk	22 gauge/2 inch/LC tip	5190-1485
	Replacement needle for 10 μL syringe	3/pk		5190-1486
25	Fixed	1/pk	22 gauge/2 inch/LC tip	5190-1494
50	Fixed	1/pk	22 gauge/2 inch/LC tip	5190-1501
100	Fixed	1/pk	22 gauge/2 inch/LC tip	5190-1508
250	Fixed	1/pk	22 gauge/2 inch/LC tip	5190-1515
500	Fixed	1/pk	22 gauge/2 inch/LC tip	5190-1522



5.0 μL



10 μL
1.0 mL



25 μL
2.5 mL



50 μL
5.0 mL



100 μL
10.0 mL



250 μL
25.0 mL



500 μL
50.0 mL

LC Manual Syringes with PTFE-Tipped Plungers

Volume (μL)	Description	Unit	Needle	Part No.
10	Syringe		22 gauge/2 inch/LC tip	5190-1492
	Replacement needle, for 10 μL syringe	3/pk		5190-1486
	Replacement plunger, with PTFE tip, for 10 μL syringe			5190-1558
25	Syringe		22 gauge/2 inch/LC tip	5190-1499
	Replacement needle	3/pk		5190-1571
	Replacement plunger, with PTFE tip, for 25 μL syringe			5190-1560
50	Syringe		22 gauge/2 inch/LC tip	5190-1505
	Replacement needle	3/pk		5190-1571
	Replacement plunger, with PTFE tip, for 50 μL syringe			5190-1561
100	Syringe		22 gauge/2 inch/LC tip	5190-1512
	Replacement needle	3/pk		5190-1571
	Replacement plunger, with PTFE tip, for 100 μL syringe			5190-1562
250	Syringe		22 gauge/2 inch/LC tip	5190-1520
	Replacement needle	3/pk		5190-1571
500	Syringe		22 gauge/2 inch/LC tip	5190-1526
	Replacement needle	3/pk		5190-1571
	Replacement plunger, with PTFE tip, for 500 μL syringe			5190-1564

DETECTOR SUPPLIES

Long-life Deuterium Lamps

The reliability of your liquid chromatography can suffer when inferior lamps produce inconsistent intensity. Noisy baselines result in wasted troubleshooting time, while frequent lamp replacements can lead to higher long-term costs

What makes Agilent lamps so different?

- **Optimum performance**—rigorous testing for noise and drift specifications, correct operating voltage, light intensity, and proper alignment ensures best performance
- **Longer life**—long-life deuterium lamps provide 50 % longer lifetime for more than 2,000 hours of use, due to our improved coating process
- **Higher signal-to-noise ratio**—the narrower aperture is designed to provide increased light intensity, decreased noise and lower limits of detection
- **Higher analytical sensitivity**—by providing greater analytical sensitivity, long-life Deuterium lamps can extend detection capabilities and improve qualification at trace levels
- **Reduced downtime**—InfinityLab lamps with RFID provide critical information and full usage traceability for planned maintenance, easier troubleshooting and lower cost of ownership

Manufactured in an ISO 9001 certified environment, Agilent lamps are rigorously tested and fully traceable throughout every step of the production process.



TIPS & TOOLS

Designed to deliver

Learn more about long-life deuterium lamps at

www.agilent.com/chem/lamps



InfinityLab long-life HiS deuterium lamp, with RFID tag, 2140-0820



Long-life deuterium lamp, G1314-60100



InfinityLab long-life HiS deuterium lamp, 5190-0917



Long-life deuterium lamp, 5182-1530

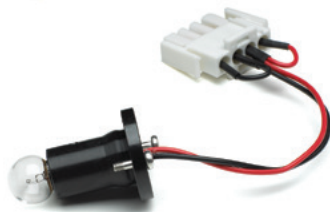

Tungsten lamp assembly, G1103-60001

Detector Lamps

Description	Used in	Part No.
Variable Wavelength Detector		
InfinityLab long-life HiS deuterium lamp with RFID tag	For G1314D/E/F and G7114A/B	G1314-60101
Long-life deuterium lamp	For G1314A/B/C, 1120 and 1220 Infinity LC with VWD	G1314-60100
Diode Array Detector/Multiple Wavelength Detector		
InfinityLab long-life HiS deuterium lamp (8pin), with RFID tag	For G4212A/B and G7117A/B/C	5190-0917
InfinityLab long-life deuterium lamp, with RFID tag	For G1315C/D, G1365C/D, G7115A, G7165A	2140-0820
Long-life deuterium lamp	For G1315A/B and G1365A/B	5182-1530
Tungsten lamp (for VIS) assembly	For G1315A/B/C/D and G1365A/B/C/D	G1103-60001
Long-life deuterium lamp	For G9309A	110715400



Variable Wavelength Detector (VWD)

VWD Flow Cell Selection						
Typical Column Length (cm)	Typical Peak Width	Recommended Flow Cell				
< = 5	0.025	Micro flow cell				High pressure flow cell for pressure above 100 bar
10	0.05	0.05-0.2 mL/min	Semimicro flow cell			
20	0.1		Standard flow cell			
> = 40	0.2					
Typical flow rate		0.05-0.2 mL/min	0.2-0.4 mL/min	0.4-0.8 mL/min	1-2 mL/min	0.05-5 mL/min
Internal column diameter		1.0 mm	2.1 mm	3.0 mm	4.6 mm	

Flow Cells and Repair Kits for VWD

Description	Use With	Specifications	Part No.	Repair Kit
Standard flow cell, RFID	G1314D/E/F, G7114B	10 mm, 14 μ L, 40 bar	G1314-60186	G1314-65061
Semimicro flow cell, RFID	G1314D/E/F, G7114B	6 mm, 5 μ L, 40 bar	G1314-60183	G1315-68713
Micro flow cell, 3 mm, RFID	G1314D/E/F, G7114B	2 μ L, 120 bar	G1314-60187	G1315-68713
Micro flow cell, 5 mm	G1314A/B/C	1 μ L, 40 bar	G1314-60081	G1314-65052
High pressure flow cell, RFID	G1314D/E/F, G7114B	10 mm, 14 μ L, 400 bar	G1314-60182	G1314-65054 G1315-68713
Preperative flow cell, 0.06 mm, RFID	G7114B	0.06 mm, 50 bar	G1314-60023	
Preperative flow cell, 3 mm, RFID	G7114B	3 mm, 50 bar	G1314-60024	
Preperative flow cell, 0.3 mm, RFID	G7114B	0.3 mm, 50 bar	G1314-60025	

Capillaries for VWD Flow Cells

Flow Cell Description	Part No.	Inlet Capillary	Part No.	Outlet Capillary	Part No.
Standard flow cell	G1314-60186	Inlet capillary, 0.17 mm id, 600 mm long	5062-8522	Waste capillary, PEEK, 0.25 mm id	5062-8535
RFID				Finger-tight PEEK fitting, 0.06 inch, 2/pk	0100-1516
Semimicro	G1314-60183	Inlet capillary, 0.12 mm id, 400 mm long	5021-1823	Waste capillary, PEEK, 0.25 mm id	5062-8535
Flow cell, RFID				Finger-tight PEEK fitting, 0.06 inch, 2/pk	0100-1516
Micro flow cell, 3 mm, RFID	G1314-60187	Inlet capillary, 0.12 mm id, 310 mm long	G1314-87301	Outlet capillary, 0.17 mm id, 120 mm long	G1314-87302
Micro flow cell, 5 mm	G1314-60081	Inlet capillary, 0.12 mm id, 400 mm long	5021-1823	Outlet capillary, 0.17 mm id, 120 mm long	G1314-87302
High pressure flow cell, RFID	G1314-60182	Inlet capillary, 0.17 mm id, 380 mm long	G1315-87311	Outlet capillary, 0.17 mm id, 120 mm long	G1314-87302
Preparative flow cell, 3 mm, RFID	G1314-60024	Stainless steel capillary, 0.5 mm id, 0.9 mm od, 250 mm long	G1315-87305		
Preparative flow cell, 0.06 mm, RFID	G1314-60023	Stainless steel capillary, 0.7 x 1000 mm	5067-5748	Outlet tubing, PTFE-ESD, 2 m length, 1.0 mm id, 1.6 mm od, with fittings (for 100 - 300 mL/min)	G1315-67304
				Outlet tubing, PTFE-ESD, 2 m length, 0.8 mm id, 1.6 mm od, with fittings (up to 100 mL/min)	G1315-67305
Preparative flow cell, 0.3 mm, RFID	G1314-60025	Tubing assembly, 6 mm id, 9 mm od	5063-6527	Outlet tubing, PTFE-ESD, 2 m length, 1.0 mm id, 1.6 mm od, with fittings (for 100 - 300 mL/min)	G1315-67304
				Outlet tubing, PTFE-ESD, 2 m length, 0.8 mm id, 1.6 mm od, with fittings (up to 100 mL/min)	G1315-67305

Special Accessory VWD

Description	Specifications	Part No.
Back pressure regulator 100 psi	For preparative scale flow cells, keeps the system pressure at 100 psi, used for low flow rates to remove air bubbles from the flow cell (e.g. MeOH/H ₂ O gradients), including 50 cm PTFE tubing, 1.6 mm od, 0.8 mm id, plus fittings	5042-6443

Diode Array Detector (DAD)/ Multiple Wavelength Detector (MWD)

Cleaning or Replacing DAD/MWD Flow Cells

- A decrease in detector performance or unusual noise levels may mean you have dirty flow cell windows
- Clean and reassemble one side of the flow cell before beginning the other side to prevent mixing the front and rear gaskets, which have different hole diameters
- While cleaning or replacing flow cell windows, if the washers fall out of the window assembly, they must be inserted in the correct order with a PTFE ring to prevent any leaks from the flow cell window
- Clean the cell body with water or isopropanol
- After opening the cell you should always use a new gasket



DAD/MWD Flow Cell Selection

Typical Column Length (cm)	Typical Peak Width	Recommended Flow Cell				
< = 5	0.025	80/500 nL flow cell				
10	0.05	Semimicro flow cell			High pressure flow cell	
20	0.1	Standard flow cell			High pressure flow cell	
> = 40	0.2	High pressure flow cell				
Typical flow rate		0.05-0.2 mL/min	0.2-0.4 mL/min	0.4-0.8 mL/min	1-2 mL/min	0.05-5 mL/min
Internal column diameter		0.3-1 mm	2.1 mm	3.0 mm	4.6 mm	

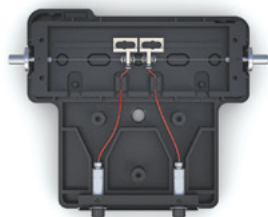

InfinityLab Max-Light HDR flow cell, interior view, to show short 3.7 mm path length for high concentrations, G4212-60032

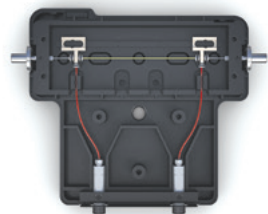

InfinityLab Max-Light cartridge cell, interior view, 60 mm path for high concentrations, G4212-60007

Flow Cells and Repair Kits for DAD/MWD

Description	Specifications	Part No.	Repair Kit Part No.
For use with G1315A/B, G1365A/B			
Standard flow cell	10 mm, 13 μ L, 120 bar	G1315-60012	
Semimicro flow cell	6 mm, 5 μ L, 120 bar	G1315-60011	
For use with G1315C/D, G1365C/D, G7115A, G7165A			
Standard flow cell, with RFID tag	10 mm, 13 μ L, 120 bar	G1315-60022	G1315-68712
Semimicro flow cell, with RFID tag	6 mm, 5 μ L, 120 bar	G1315-60025	G1315-68713
Micro flow cell, with RFID tag	3 mm, 2 μ L, 120 bar	G1315-60024	G1315-68713
Micro high-pressure flow cell	6 mm, 1.7 μ L, 400 bar	G1315-60015	
Flow cell, 500 nL	10 mm, 50 bar	G1315-68724	
Flow cell, 80 nL	6 mm, 50 bar	G1315-68716	
Preparative flow cell	3 mm, 120 bar, stainless steel	G1315-60016	G1315-68712
Preparative flow cell	0.3 mm, 20 bar, quartz	G1315-60017	
Preparative flow cell	0.06 mm, 20 bar, quartz	G1315-60018	
Bio-inert standard flow cell, with RFID tag	10 mm, 13 μ L, 120 bar	G5615-60022	
Flow cell SFC-LD	3 mm, 2 μ L, 400 bar	G4301-60200	
Flow cell for 1260 Infinity SFC	10 mm, 13 μ L, 400 bar	G4301-60100	
InfinityLab Max-Light cartridge cells for use with G4212A/B, G7117A/B			
Max-Light cartridge cell*	10 mm, $\sigma_v = 1.0 \mu$ L, with RFID tags	G4212-60008	
Max-Light cartridge cell*	60 mm, $\sigma_v = 4 \mu$ L, with RFID tags	G4212-60007	
Max-Light cartridge test cell*	Recommended instrument diagnostic tests	G4212-60011	
Max-Light ultra low dispersion flow cell*	10 mm, $\sigma_v = 0.6 \mu$ L, with RFID tags	G4212-60038	
Max-Light High Dynamic Range (HDR) flow cell*	3.7 mm, $\sigma_v = 0.8 \mu$ L, with RFID tags	G4212-60032	

* Maximum Operating Pressure (MPO): 70 bar. The maximum pressure at which a system can operate continuously under normal conditions.
Maximum Incidental Pressure (MIP): 150 bar. The maximum pressure which the system can experience during a short time.

Capillaries for DAD/MWD Flow Cell

Flow Cell Description	Part No.	Inlet Capillary	Part No.	Outlet Capillary	Part No.
Standard flow cell, with RFID tag	G1315-60022	Inlet capillary with heat exchanger, 0.17 mm id, 590 mm long	G1315-87321	Outlet capillary, 0.17 mm id, 200 mm long	G1315-87302
Standard flow cell	G1315-60012			Outlet capillary, 0.12 mm id, 200 mm long	G1315-87306
Semimicro flow cell, with RFID tag	G1315-60025	DAD heat exchanger capillary, 0.17 mm id, 310 mm long	G1315-87319	Outlet capillary, 0.17 mm id, 200 mm long	G1315-87302
Semimicro flow cell	G1315-60011			Outlet capillary, 0.12 mm id, 200 mm long	G1315-87306
				Outlet capillary, 0.17 mm id, 200 mm long	G1315-87302
				Outlet capillary, 0.12 mm id, 200 mm long	G1315-87306
Micro flow cell, with RFID tag	G1315-60024	DAD heat exchanger capillary, 0.12 mm id, 310 mm long	G1315-87339	Outlet capillary, 0.17 mm id, 200 mm long	G1315-87302
Micro high-pressure flow cell	G1315-60015			Inlet capillary with heat exchanger, 0.12 mm id, 290 mm long	G1315-87325

80 nL and 500 nL Flow Cell Supplies

Description	Unit	Part No.
Fitting screw	10/pk	5063-6593
Double winged nuts and 0.03 inch ferrules	10/pk	5065-4422
Ferrule and stainless steel lock ring, lite touch, 0.03 inch	10/pk	5063-6592
Union adjustment tool	2/pk	5022-2146
ZDV universal union, stainless steel, no fittings	1/pk	5022-2184
Open end wrench, 4 mm		8710-1534

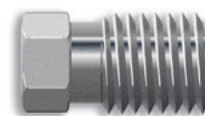

Fitting, screw, 5063-6593

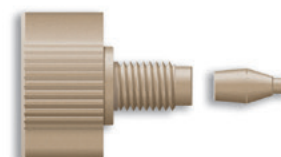

Double winged PEEK nut & ferrule (WPF), 5065-4422

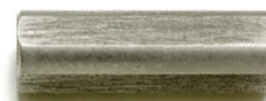

ZDV universal union, 5022-2184



Wrench, open end, for use with PEEK-coated fused silica capillaries, 8710-1534

500 nL Flow Cell and Replacement Parts

Description	Comments	Part No.
Flow cell, 500 nL	Contains quartz flow cell with 10 mm path length and 500 nL volume and connecting capillaries, max 50 bar pressure	G1315-68724
Quartz cell body, 10 mm		G1315-80001
Cell seal assembly, 500 nL		G1315-87101
Capillary, fused silica/PEEK, 100 µm id, 30 cm long	Inlet	G1315-87333
Capillary, fused silica/PEEK, 50 µm id, 40 cm long	Inlet	G1315-87323
Capillary, fused silica/PEEK, 100 µm id, 12 cm long	Outlet	G1315-87338
Capillary, fused silica/PEEK, 50 µm id, 12 cm long	Outlet	G1315-87328

80 nL Flow Cell and Replacement Parts

Description	Comments	Part No.
Flow cell, 80 nL	Contains quartz flow cell with 6 mm path length and 80 nL volume and connecting capillaries, maximum 50 bar pressure	G1315-68716
Quartz cell body, 80 nL, 6 mm path length		G1315-80002
Capillary, fused silica/PEEK, 50 µm id, 40 cm long	Inlet	G1315-87323
Capillary, fused silica/PEEK, 50 µm id, 12 cm long	Outlet	G1315-87328
Capillary, fused silica/PEEK, 25 µm id, 20 cm long	Inlet	G1315-87313
Capillary, fused silica/PEEK, 25 µm id, 60 cm long	Outlet	G1315-87318
1/32 in ferrule and stainless steel lock ring, lite touch		5063-6592

Preparative Flow Cells and Replacement Parts

Description	Part No.
Preparative flow cell, 0.3 mm, 20 bar, quartz	G1315-60017
Preparative flow cell, 0.06 mm, 20 bar, quartz	G1315-60018
Tubing, PTFE, 0.8 mm id, 2 m	G1315-67301
Tubing, PTFE, 0.5 mm id, 0.8 m	G1315-67302
Cell housing	G1315-27705
Finger-tight fitting, PEEK, 0.06 inch, 2/pk	0100-1516
Quartz body, 0.3 mm	G1315-80004
Preparative flow cell, stainless steel, 3 mm, 120 bar	G1315-60016
Connecting capillary, stainless steel, 0.5 mm, 250 mm	G1315-87305



Finger-tight PEEK fitting, 0.06 inch, 0100-1516

Detector Maintenance Kits

Detector Maintenance Kits

Description	Kit Contents	Part No.
Variable Wavelength Detector (VWD)		
Standard "D" type flow cell kit For G1314A/B/C/D/E/F	Includes windows (2/pk), gaskets #1 (2/pk), gaskets #2 (2/pk)	G1314-65061
Semimicro flow cell kit	Includes windows (2/pk), gaskets: standard #1 (2/pk), semimicro #1, semimicro #2	G1314-65056
Micro flow cell kit	Includes windows (2/pk), gaskets #1 (2/pk), gaskets #2 (2/pk)	G1314-65052
Cell repair kit, semimicro cell For G1315A/B, G1365A/B, G1315C/D, G1365C/D	Includes window screw kit, 4 mm hexagonal wrench, seal kits	G1315-68713
High-pressure flow cell kit	Includes windows (2/pk), Kapton gaskets (2/pk), and PEEK rings (2/pk)	G1314-65054
Diode Array Detector (DAD)/Multiple Wavelegnth Detector (MWD)		
Cell repair kit for standard cell For G1315A/B, G1365A/B, G1315C/D, G1365C/D	Includes window screw kit, 4 mm hexagonal wrench, seal kit	G1315-68712
Cell repair kit, semimicro cell For G1315A/B, G1365A/B, G1315C/D, G1365C/D	Includes window screw kit, 4 mm hexagonal wrench, seal kits	G1315-68713

In a tight spot?

Try an InfinityLab Quick Turn fitting

For instrument connections that are too tight for Quick Connect fittings, you can rely on Agilent InfinityLab Quick Turn fittings. Like our Quick Connect fittings, they leverage a proprietary spring-loaded design for zero dead volume and a sure connection.

As easy as closing a lever: The proprietary Agilent design features a spring-loaded mechanism for zero dead volume and a sure, tight connection.

Turn to **Page 106**.





G4260B 1260 Series ELSD

Other Detectors

G4260B 1260 and G4261B 1290 Series Evaporative Light Scattering Detector Supplies

Description	Part No.
ELSD air adapter kit	PL0890-0640
Solvent waste container, 500 mL	PL0890-0320
Gas inlet frit, 10 µm	PL0890-0525

1200 Series Evaporative Light Scattering Detector

Description	Kit Contents	Part No.
Seal kit, for nebulization chamber	Includes seal kits	G4218-68010
Analog cable		PL0880-0310
Gas inlet tube, 2 m		PL0890-0305
Rear exhaust hose, PVC 2 m		PL0890-0310
Solvent waste tube, 2 m		PL0890-0315
RS232 communication cable		PL0890-0325
Trigger cable, for dimension software		PL0890-0345
Remote start cable, for third party LCs only		PL0890-0350

Refractive Index Detector (RID) Supplies (G1362A, G7162A/B)

Description	Part No.
Tubing kit Includes 300 mm recycle valve to recycle port, 200 mm recycle valve to waste port, 120 mm purge valve to recycle valve, 270 mm purge valve to sample cell, 170 mm purge valve to reference cell	G1362-68709
Interface tubing kit Includes 1/8 inch ferrule, 1/3 inch nut, PTFE tubing	G1362-68706
Interface capillary, 400 mm, 0.17 mm id	G1362-87300
Restriction capillary, 0.17 mm id	G1362-87301

Fluorescence Detector (FLD) Supplies (for G1321A/B, G7121A)

Description	Part No.
Detector lamp	2140-0600
Flow cell, 8 μ L, 20 bar	G1321-60005
Flow cell, 4 μ L, 20 bar	G1321-60015
Cuvette kit, 8 μ L, 20 bar	G1321-60007
Includes tubing, stainless steel fitting, front and back ferrule, PEEK fitting, syringe needle and syringe	
Corrugated tubing, polypropylene, 6.5 mm id, 5 m	5062-2463
Tubing, PTFE, FEP, 0.7 mm id, 5 m	5062-2462
Finger-tight fitting, PEEK, 0.06 inch, 2/pkg	0100-1516
Column connecting capillary with fittings, 380 x 0.17 mm	G1315-87311
Front ferrule, stainless steel, 1.6 mm, 10/pkg	5180-4108
Back ferrule, stainless steel, 0.06 inch, 10/pkg	5180-4114
Swagelok, 1.6 mm, screw	5061-3303
Fluorescence detector calibration sample, 1 g glycogen	5063-6597
Open end wrench, 0.25 and 0.31 inch	8710-0510
Glass syringe	9301-1446
Syringe needle	9301-0407
Disposable syringe, 20 mL, 100/pkg	5190-5103
Disposable syringes, 20 mL, polypropylene, 10/pkg	5067-6624
FLD wavelength calibration kit	G7121-68001
Includes calibration sample (1 g), premium syringe filters (100/pkg), glass syringe with needle, finger-tight fitting PEEK, technical note	



Flow cell for G1321A fluorescence detector, G1321-60005



Stainless steel front ferrules, 5180-4108



Back ferrules 1/16 in, 5180-4114

TIPS & TOOLS

For an introduction to GPC/SEC, see primer 5990-6969EN at www.agilent.com/chem/library, or visit www.agilent.com/chem/gpcsec





BIO-INERT SUPPLIES

Robust and true bio-inertness, for your bio-applications

The Agilent 1260 Infinity II Bio-inert LC and Agilent bio-inert supplies provide dedicated InfinityLab solutions for your biomolecule analysis. Stainless-steel clad PEEK capillaries are the arteries and veins of the Bio-inert LC. The PEEK enables a metal free sample flowpath and the stainless steel mantling enables use of pressures of up to 600 bar. This metal-free sample flowpath ensures the integrity of your biomolecules, minimizing unwanted surface interactions. Together with the AdvanceBio column portfolio, or BioLC columns for SEC, IEX, reverse phase, and peptide mapping Agilent provides a complete solution for your bio-applications.

1260 Infinity & Infinity II Bio-inert Quaternary Pump Parts (G5611A/G5654A)

Description	Part No.
Bio-inert purge valve	G5611-60062
Bio-inert active inlet valve	G5611-60025
Bio-inert cartridge, for active inlet valve, 600 bar	G5611-60020
Bio-inert outlet valve	G5611-60067
Sapphire piston for 1220/1260/1290 Infinity II	5067-4695
Bio-inert piston seal	G5611-21503
Bio-inert wash seal	0905-1731
Bio-inert seal keeper	G5611-26210
Bio-inert support ring	G5611-63010

TIPS & TOOLS

For information on the Agilent's broad portfolio of complementary BioLC columns, turn to **Pages 132–133**, or visit www.agilent.com/advancebio



1260 Infinity LC Bio-inert High Performance Autosampler Parts (G5667A)

Description	Part No.
Bio-inert 2 position/6 port injection valve	5067-4131
Rotor seal, 3 grooves, maximum 600 bar	0101-1416
Bio-inert stator	5068-0060
Stator face, ceramic	0100-1851
Bio-inert needle assembly	G5667-87200
Tool for needle adjustment	G5667-40500
Seat, PEEK/stainless steel, 0.17 x 105 mm, RLO/RLO, bio-inert	G5667-81008
Sapphire piston, slim base	5067-4695
Bio-inert piston seal	G5611-21503
Loop, PEEK/stainless steel, 100 µL, RLO/RLO, bio-inert	G5667-81006
Loop flex assembly, 40 µL	G4226-60415
Vial plate, for 40 x 2 mL vials, 1/pk	5023-2471
Vial plate, for 54 x 2 mL vials, 6/pk	G2255-68700



Stator face, ceramic, 0100-1851

1260 Infinity II LC Bio-inert Multisampler Parts (G5668A)

Description	Part No.
Needle, for bio-inert multisampler	G5668-87200
Seat, for bio-inert multisampler, 0.17 mm id	G5668-87017
Rotor seal, 2 groove, elongated groove	5068-0209
Stator face, ceramic	0100-1851
Sample loop, 100 µL, bio-inert	G5668-60500
Additional standard drawer kit, double height (2H), 1/pk	G7167-60020
Additional drawer kit, single-height (1H), 2/pk	G7167-60021
Additional drawer kit, triple-height (3H), 2/pk	G7167-60022
Vial plate, for 54 x 2 mL vials, 6/pk	G2255-68700
Vial plate, for 40 x 2 mL vials, 1/pk	5023-2471
Multidraw kit, 400 bar, bio-inert	G5667-68711
Preventive maintenance kit, for bio-inert multisampler	G5668-68730
Includes needle, seat, rotor seal	



Rotor seal, 2 position/6 port, 600 bar for G1316B, 0101-1409

1260 Infinity & 1260 Infinity II Bio-inert Valve Parts

Description	Part No.	Rotor Seal (PEEK)	Stator Head	Stator face
2 position/6 port valve head, 600 bar, bio-inert	5067-4148	0101-1409	5068-0060	0100-1851
2 position/10 port valve head, 600 bar, bio-inert	5067-4132	5068-0041	5068-0040	5068-0095
4-Column selector valve head, 600 bar, bio-inert	5067-4134	5068-0045	5068-0044	5068-0093
12 position/13 port solvent selector valve head, 200 bar, bio-inert	5067-4159	0101-1288	5068-0097	0101-1288

Bearing ring for all valves: p/n 1535-4045

1260 Infinity & 1260 Infinity II Bio-inert Detector Parts

Description	Used In	Part No.
Bio-inert standard flow cell, with RFID tag	G1315C/D, G1365C/D, G7117A, G7165A	G5615-60022
Bio-inert FLD flow cell	G1321B/C	G5615-60005

1260 Infinity LC Bio-inert Fraction Collector Parts (G5664A)

Description	Part No.
Fraction collector kit, includes:	G5664-68712
• Bio-inert PEEK tubing, valve to needle (G5664-86703)	
• Bio-inert PEEK tubing, valve to detector (G5664-86706)	
• Finger-tight fitting, PEEK, 0.06 inch, 2/pk (0100-1516)	
• Technical note	
Test tubes, 12 x 100 mm, 8 mL, 250/pk	5022-6531
Test tubes, 16 x 100 mm, 13 mL, 250/pk	5022-6532
Test tubes, 25 x 100 mm, 35 mL, 100/pk	5042-6459
Test tubes, 30 x 100 mm, 58 mL, 100/pk	5042-6458

1260 Infinity LC Bio-inert General Supplies

Description	Used In	Part No.
Bio-inert low dispersion heat exchanger	G1316C	G5616-81000
InfinityLab bio-inert Quick-Connect heat exchanger, 0.17 mm id, includes Quick Connect fitting and UHP-FF fitting*	G7116A/B	G7116-60009
Bio-inert Quick-Connect heat exchanger, without fittings	G7116A/B	G7116-60041
Fraction collector kit, includes: <ul style="list-style-type: none"> • Bio-inert PEEK tubing, valve to needle (G5664-86703) • Bio-inert PEEK tubing, valve to detector (G5664-86706) • Finger-tight fitting, PEEK, 0.06 inch, 2/pk (0100-1516) • Technical note 	G5664A Bio-inert fraction collector	G5664-68712
Bio-inert union, stainless steel with PEEK insert, 600 bar	Bio-applications	5067-4741
Tubing, PEEK, 1.6 mm od, 0.18 mm id, 1.5 m	Bio-applications	0890-1763

*additional bio-inert union (p/n 5067-4741) required if not connected to column selection valve



InfinityLab bio-inert Quick-Connect heat exchanger, with fittings, G7116-60009



Bio-inert union, 5067-4741

TIPS & TOOLS

For our range of bio-inert capillaries, turn to **Page 110-111**.

To learn more about our comprehensive LC portfolio, go to www.agilent.com/chem/lc



PURIFICATION SUPPLIES

Purely better solutions for compound purification

Agilent offers the most comprehensive portfolio of flexible and reliable solutions for sample purification by LC. With analytical, semipreparative, preparative, and pilot-scale instrumentation, columns, and supplies Agilent has a solution that meets your purification needs and your budget.

Agilent 1290 Infinity II Open-Bed Fraction Collector:

Set new benchmarks in your LC purification workflows, while occupying a minimum of bench space. This new Agilent module facilitates automated, high-capacity fraction collection with lowest delay volumes to minimize peak dispersion and carryover. Variable bed configuration for collection of individual fractions or large volumes, as well as capability to cluster up to four fraction collectors.



Agilent 1260 Infinity automated LC/MS purification system:

A truly automated LC/MS system providing pure fractions without method development or scale-up work - meeting the demands for secure compound confirmation and high throughput.

Agilent 1260 Infinity automated LC/UV purification system:

A truly automated LC/UV system providing pure fractions without method development or scale-up work - comfortably with minimum investment and training.

Agilent 1260 Infinity analytical scale purification system:

An indispensable tool in your purification workflow - on one system with one software you can perform both analytical UHPLC and preparative LC/MS.

Agilent 1260 Infinity preparative scale purification system:

Offers ultimate flexibility - use it as a workhorse for automated, high-throughput applications, or as a method scale-up solution for optimizing resolution and recovery.

General Supplies

Description	Comments	Part No.
Bottle head assembly for preparative system	Includes bottle head, tubing (PTFE, 4.7 mm od), solvent inlet filter (glass, 40 µm) and frit adapters	G1361-60022
Frit adapter, PTFE, for 4.7 mm od tubing		G1361-23205
Glass filter, solvent inlet, 40 µm pore size		3150-0944
Solvent bottle, clear, 2 L, 2 inlets	GL45 thread	5065-4421
Solvent bottle, amber, 2 L	GL45 thread	9301-6341
Solvent bottle, clear, 2 L	GL45 thread	9301-6342



Solvent bottle, clear, 2 L, 2 inlets, 5065-4421

Supplies for Preparative Pump (G1361A)

Description	Comments	Part No.
Filter assembly, stainless steel, with PEEK ring, 2 µm pore size		5022-2192
Valve assemblies (inlet/outlet), for preparative pumps	Valve cartridge, single seat, short	G1361-60012
Valve assembly double seat	Requires valve adapter, long, out (G1361-25202) and valve adapter, long, in (G1361-25203)	G1361-60052
Sapphire piston (preparative)		G1361-22402
Piston seal		5022-2188
O-ring, Viton, 30 mm		0905-1516



Valve cartridge, single seat, short, G1361-60012



Loop capillary, stainless steel, 100 μ L, 01078-87302



Twin needle seat assembly, for G2258A, G2258-87102

Supplies for Preparative Autosampler (G2260A)

Description	Part No.
Needle assembly	G2260-87201
Needle seat	G2260-87101
Multi draw loop, 5 mL	G2260-68711
Plunger assembly, 900 μ L	5062-8587
Loop capillary, stainless steel, 100 μ L	01078-87302
Metering seal, 900 μ L	0905-1294
Loop extension capillary, stainless steel, 900 μ L	G1313-87303
Union, high-flow, stainless steel, no fitting	5022-2133
Rotor seal, PEEK, and stator face, PEEK, kit	0101-1268
Isolation seal	0100-1852

Supplies for Dual Loop Autosampler (G2258A)

Description	Part No.
Needle kit	G2258-68710
Twin needle seat assembly, for G2258A	G2258-87102
Buffer loop tubing assembly, PTFE	G2258-87300
Buffer loop extension assembly	G2258-60002
Rotor seal, vespel, 5-groove, 0.65 inch od	0100-2415
Piston seal	0905-1599
Piston for G2258A Dual Loop ALS, 5 mL	G2258-60003
Capillary loop, 2 μ L, stainless steel	5068-0031
Capillary loop, 5 μ L, stainless steel	5068-0032
Capillary loop, 10 μ L, stainless steel	5068-0051
Capillary loop, 20 μ L, stainless steel	5068-0033
Capillary loop, 50 μ L, stainless steel	5068-0034
Capillary loop, 100 μ L, stainless steel	5068-0035

Test Tubes

Tube Dimensions (id x height)	Unit	Volume	Use with	Part No.
12 x 100 mm	250/pk	8 mL	G1364B, G7159B	5022-6531
12 x 150 mm	250/pk	11 mL	G7159B	5190-9093
16 x 100 mm	250/pk	13 mL	G1364B, G7159B	5022-6532
16 x 150 mm	250/pk	21 mL	G7159B	5190-9092
25 x 100 mm	100/pk	35 mL	G1364B, G7159B	5042-6459
25 x 150 mm	100/pk	55 mL	G7159B	5190-9091
30 x 100 mm	100/pk	58 mL	G1364B, G7159B	5042-6458
30 x 150 mm	100/pk	78 mL	G7159B	5190-9090

Trays for Fraction Collectors (G1364B/C)

Hole Diameter (mm)	No. of Tubes	Part No.
30	40	G1364-84523
25	60	G1364-84524
16	126	G1364-84525
12	215	G1364-84516

Funnel Tray for Fraction Collectors (G1364B/C)

Description	Part No.
40 funnel tray for G1364C fraction collector	G1364-84532
Tray for 2 well plates, with 10 funnels, cooled	G1364-84522
Funnel seals for G1364-84502 tray, 10/pk	G1364-68730
Tubing for funnels of G1364-84502, 10/pk	G1364-86707

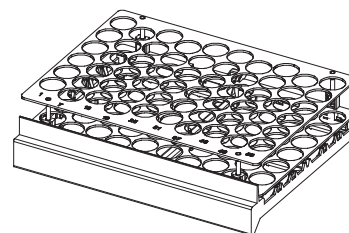

Tray holding 60 tubes, 25 x 100 mm, 35 mL

1290 Infinity II LC OpenBed Fraction Collector Supplies (G7159B)

Description	Part No.
1290 Infinity II HiP PrepFC tubing kit, 50 mL	G9321-60952
1290 Infinity II HiP PrepFC tubing kit, 200 mL	G9321-60951
Fitting, 1/4-28, for ESD-PEEK tubing, 2.5 mm od	5023-2871
Fitting, 1/4-28, for ESD-PEEK tubing, 2.0 mm od	5023-2872
Fitting, 1/4-28, for ESD-PEEK tubing, 1.6 mm od	5023-2874
Delay calibrant	G9321-60592
Fraction collection remote Y-cabel (3000 mm)	5188-8057



Tube container, 36 tubes, G9321-60055

Tube Containers and Drawer (G7159B)

Description	Part No.
Drawer, for G7159B, ambient temperature	G9321-60085
Tube container, 30 x 150 mm, 10 tubes, ambient	G9321-60015
Tube container, 30 x 100 mm, 10 tubes, ambient	G9321-60058
Tube container, 25 x 150 mm, 18 tubes, ambient	G9321-60025
Tube container, 25 x 100 mm, 18 tubes, ambient	G9321-60035
Tube container, 16 x 150 mm, 36 tubes, ambient	G9321-60129
Tube container, 16 x 100 mm, 36 tubes, ambient	G9321-60055
Tube container, 12 x 150 mm, 72 tubes, ambient	G9321-60131
Tube container, 12 x 100 mm, 72 tubes, ambient	G9321-60045

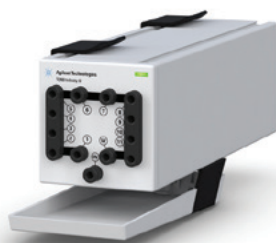

1260 Infinity II Preparative Valve-Based Fraction Collector, G7166A

1260 Infinity II Preparative Valve-Based Fraction Collector Supplies (G7166A)

Description	Part No.
Tubing, PTFE, ESD-stripped, 1.6 mm id x 2.5 mm od, 6 m length	5023-2882
Tubing, PTFE, ESD-stripped, 1.2 mm id, 2.0 mm od, 2 m length	5023-2878
Fitting, 1/4-28, for ESD-PEEK tubing, 2.0 mm od	5023-2872
Fitting 1/4-28, for 2.5 mm id ESD-PEEK, 6/pk	5023-2883
Tubing, polyurethane ether based, 4 mm id, 6 mm od	3710043100
Elbow, 6 mm, push fit, male 1/8 BSP	1610140200

GENERAL SUPPLIES

Your Agilent LC system arrives with a full complement of tools needed to perform general maintenance and operation procedures. Should you need additional or replacement tools, Agilent offers a selection of high-precision, high-quality, stainless steel tools, to avoid any deformation of the screws or nuts.

LC Tools

Description	Part No.
LC tool kit	G7120-68708
1290 Infinity and Infinity II pump service kit	5067-4699
1290 Infinity pump and Infinity II service kit, for Long Life and Easy Maintenance pump heads	5067-6652
Compact tool kit	G4296-68715
Torque wrench, 1 to 25 Nm	5067-5688
Bit kit, for torque wrench	5023-0282
Open end wrench, 14 mm, for active inlet and purge valves	8710-1924
Hex driver, SW-4 slitted	5023-2504
Hex driver, SW-5 slitted	5023-2503
Hex driver, SW-6.35 slitted	5023-2502
LC tools, hex key kit	5023-2524
Includes long hex keys (1.5 / 2 / 2.5 / 3 / 4 / 5 mm) and universal handle grip	
Restriction capillary, 0.12 mm id, 2 m length	5022-2159
Multifunction tool	8710-2474
Insert tool (pump seals)	01018-23702
Blank nut, stainless steel	5067-6127
Blank nut, long, 10-32, PEEK with stainless steel core, finger-tight, for system diagnostic tests	5043-0277
Blank nut, stainless steel, for M4 fittings ports	5067-6141
Plastic tubing cutter	8710-1930
Blades, for plastic cutter, 5/pk	8710-1931
Mounting tool, for fitting SW5 and 0.25 inch screws, maximum torque 0.8 Nm	5043-0915
Disposable syringes, polypropylene, 20 mL, 10/pk	5067-6624
Luer-Lok needle assembly, PEEK	5190-0924
Syringe adapter, to connect to 1/4-28 thread fittings	9301-1337



Compact tool kit, G4296-68715



Blank nut, long, 10-32, PEEK with stainless steel core, 5043-0277



Plastic tubing cutter, 8710-1930



Bio-inert mounting tool, 5043-0915



Blank nut M4, stainless steel, 5067-6141



InfinityLab Flex Bench Family

The demand for flexibility in today's lab is high. As LC/MS is being used more often, heavy stationary LC instruments can hinder productivity.

The innovative InfinityLab Flex Bench system, engineered by Agilent, provides an easily adjustable and maneuverable way for you to configure your instrument to suit your needs, anywhere in the lab.

Keep more of what you need close at hand

The adjustable, sturdy steel bench protects your sensitive LC system from accidental damage, while giving you fast, safe access to instrument components, solvent bottles, pumps, columns, and accessories. The Flex Bench allows you to:

- Modify the height of your LC instrument, for easy access to solvent bottles and increased instrument optimization, so that you can readily move modules to minimize dead volume for
- Fast LC. Safely configure your instrument to suit the way you work.
- Move instruments where you need them, when you need them.
- Whether you want to work next to your MS or move analysts to new projects the InfinityLab Flex Bench system lets you optimize your space while taking the hassle out of instrument relocation.

Get more flexibility in how you set up your LC system

The InfinityLab Benchtop system is engineered to provide an adjustable and safe way to optimize space, and configure the LC system to suit needs for higher productivity.

InfinityLab Flex Bench System

Description	Comments	Part No.
Flex Bench	79 cm width, 79 cm depth, 165 cm height, 150 kg maximum load, comes with shelf assemblies (x 4) and waste bin	5043-1252
Flex Bench, with power strip		5043-1759
Benchtop	Includes accessory shelf assemblies (x 3)	5043-1711
Benchtop, with power strip		5043-1740
Accessories		
Shelf assembly	50 kg maximum load	5043-1287
Shelf assembly, special	50 kg maximum load Allows for the additional attachment of three external valve drives to the lower side of the shelf	5043-1245
Accessory shelf assembly	50 kg maximum load Required for mounting tray (p/n 5043-1725) and drawer (p/n 5043-1735)	5043-1750
Tray		5043-1725*
Drawer		5043-1735*
Monitor holder		5043-1745*
Waste bin		5043-1278
Power cord		8121-2258
Replacement hardware kit, for Flex Bench	Includes screws, nuts, bolts, tools, and two replacement casters (one type each)	5043-1289

*Available end of 2017



Benchtop, 5043-1711

TIPS & TOOLS

For more information on the InfinityLab Flex Bench System, enter 5991-5163EN at www.agilent.com/search



RRLC inline filter, 5067-1551



Low dispersion inline filter, 01090-68702



Semiprep filter, 5064-8273



High pressure semiprep filter, 5022-2165

HPLC Inline Filters

Column inlet frit contamination can increase column backpressure and reduce efficiency. Microbore column blockages are a particular problem, due to the small diameter of the inlet frit. To prevent blockages, always use the appropriate filters in your LC system. Agilent offers two types of high pressure inline filter kits for use with any HPLC system.

HPLC Inline Filters

Description	Frit Porosity (µm)	Frit Inlet id (mm)	Comments	Part No.	Replacement Frits
Low dispersion inline filter, includes two frits, 2.1 mm, 2 µm pore size filter holder with inserts, 60 x 0.12 mm connecting capillary	0.2	4.6	max 600 bar	5067-1553	5067-1562, 10/pk
RRLC inline filter, 2.1 mm, 0.2 µm pore size filter, connecting capillary, max 600 bar	0.2	2.1	max 600 bar	5067-1551	5067-1555, 6/pk
Low dispersion inline filter, includes two frits, 2.1 mm, 2 µm pore size filter holder with inserts, 60 x 0.12 mm connecting capillary	2 0.5	2.1	< 1 mL/min	01090-68702	280959-904, 10/pk 280959-907, 10/pk
Universal inline filter, includes two frits, 4.8 mm, 2 µm pore size filter holder with inserts, 130 x 0.25 mm connecting capillary	2	4.8	1-5 mL/min	01090-68703	01090-27609, 2/pk
Semiprep filter	0.5	12.7	1-5 mL/min	5064-8273	5022-2185
High pressure semiprep filter	10	19	5-10 mL/min	5022-2165	5022-2166, 10/pk
Prep filter	10		10-100 mL/min	5065-4500	
Inline filter for G1311A	Recommended when high salt concentrations are used			G1311-60006	
1290 Infinity II inline filter	0.3	2.0	1300 bar	5067-6189	5023-0271, 5/pk

Solvent Filters/Degassers

An added benefit of filtering solvents is that degassing occurs at the same time. This is particularly beneficial if you do not have an on-line degasser in your system. The benefits of solvent filtration:

- Degasses eluents as particulates are removed
- Prevents the formation of spurious peaks within the detector due to solvent outgassing at the low-pressure end of the chromatograph
- Increases solvent inlet lifetime
- Eliminates pump downtime caused by air locks and particulates in check valves
- Decreases piston wear, while increasing column life

Solvent Filters/Degassers

Description	Part No.
HPLC solvent filter/degasser assembly	3150-0577
Replacement Parts for 3150-0577	
Glass funnel, 250 mL	5188-2743
Sieve, PTFE coated	5188-2744
Seal, PTFE	5188-2745
Funnel base, glass	5188-2746
Filter Membranes	
Regenerated cellulose filter membranes, diameter 47 mm, pore size 0.45 μ m, 100/pk	3150-0576
Nylon filter membranes, diameter 47 mm, pore size 0.45 μ m, 100/pk	9301-0895
PTFE filter membranes, diameter 47 mm, pore size 0.45 μ m, 10/pk	3150-0509



Glass solvent filter degasser, 3150-0577



Caffeine OQ/PV sample for dissolution test,
5042-6476

LC Standards

LC Standards

Description	Part No.
Caffeine standards kit for LC OQ/PV Includes one 10 mL ampoule: 125.0 g/mL; four 5 mL ampoules: 5.0, 25.0, 250.0, and 500.0 g/mL caffeine in water	8500-6762
Caffeine standards kit for capillary OQ/PV Includes 5 ampoules, 5 mL: 2.0, 4.0, 20.0, 100.0, 200.0 g/mL caffeine in water	5065-4420
Caffeine OQ/PV sample for dissolution test, 150 mg/L caffeine in water, 500 mL	5042-6476
Caffeine standard, 250 g/mL	G4218-85000
Enterprise Edition caffeine standard kit	5190-0488
Fluorescence detector calibration sample, 1 g glycogen	5063-6597
RI detector OQ/PV test sample Includes 5 ampoules, 5 mL: 5, 10, 15, 25, and 50 mg/mL glycerin in water	5064-8220
Isocratic and gradient standards Contains 0.15 % diethylphthalate, 0.01 % biphenyl, and 0.03 % terphenyl in MeOH (w/w). Gradient standard includes 0.32 % dioctyl phthalate as well. Two 0.5 mL ampoules of each.	01080-68702
Isocratic standard, 0.5 mL ampoule	01080-68704
Check out sample, phenone, 1 mL ampoule	5188-6529
Chip cube high mass reference (HP-1221), 0.5 mL	G1982-85001
Chip cube high mass solvent (FC-70), 25 mL Fluorinert	G1982-85002
Chip cube low mass reference sample, 1 g methyl stearate	G1982-85003
ESI+APCI LC demo sample Contains 5 x 1 mL ampoules with 33 ng/L crystal violet, 77 ng/L carbazole, 300 ng/L 9-phenanthrol, 1 ng/L 1-hexanesulfonic acid sodium salt in water/methanol 60:40	G1978-85000
ES-TOF biopolymer reference standard kit Contains 7 x 2 mL ampoules with 5 mM purine, 1 M ammonium formate, 0.5 mM HP-0285, 0.1 mM HP-0321, 0.2 mM HP-1221, 0.2 mM HP-1821, 0.5 mM HP-2421	G1969-85003
HSA peptide standard mix kit 2 vials with 6 lyophilized peptides	G2455-85001

TIPS & TOOLS

Agilent has made vial, cap, and septum selection easy with its new Interactive Vial Selection Tool, available online in both desktop and mobile versions. The tool identifies the right vial and closures for your particular application, and provides the rationale for the choices offered.

Visit www.agilent.com/chem/SelectVials



LC CAPILLARIES

Your LC systems components are only as reliable as the connections between them

Think of your LC system as a chain from analyte to pump to column to detector to waste. Every link must operate at maximum efficiency, or the whole chain risks failure - compromising your results.

Agilent LC capillaries: Your link to analytical success

At Agilent, we invest heavily in the quality of our capillary connections. All are engineered and manufactured to the same quality standards as our columns and instruments, so you can protect the integrity of your results at every step of your LC flow path.

Using our flexible stainless steel and polymer capillaries and fittings can provide:

- Tight, leak-free connections
- Zero dead volume connections
- An inert surface (when using polymer or PEEK/stainless steel bio-inert capillaries)
- High flexibility without sacrificing durability
- Easy cutting to the exact length you need (PEEK tubing)
- Predefined lengths for specific flow path locations (capillaries)

In addition, all Agilent capillaries are precision cut with square ends, are burr-free, have no inner-diameter distortion, and come in a variety of materials to suit your needs.



Agilent's unique laser welding process ensures that the capillary ends are absolutely flat, eliminating any chance of capillary-induced dead volume.

TIPS & TOOLS

Easily find the right capillaries for your instrument with the Capillaries Selection Tool—go to www.agilent.com/chem/selectcapillaries

Capillary description keys

The tables below will be your guide to identifying the proper specifications for your capillary. On all capillaries, dimensions are noted in id (mm), length (mm), and where applicable, volume (µL). When you receive your capillary, these abbreviations are printed on the packaging.

Using the guide: This fitting is coded as SPF, for Swagelok, PEEK, Finger-tight.

Type	
Key	Description
Capillary	Connection capillaries
Loop	Loop capillaries
Seat	Autosampler needle seats
Tube	Tubing
Heat exchanger	Heat exchanger

Material	
Key	Description
SST	Stainless steel
Ti	Titanium
PK	PEEK
FS/PK	PEEK-coated fused silica*
PK/SST	Stainless steel-coated PEEK**
PTFE	PTFE
FS	Fused silica

*Fused silica in contact with solvent

**PEEK in contact with solvent

Fitting Left/Fitting Right	
Key	Description
W	Swagelok + 0.8 mm port id
S	Swagelok + 1.6 mm port id
M	Metric M4 + 0.8 mm port id
E	Metric M3 + 1.6 mm port id
U	Female Swagelok union
L	Long
X	Extra long
H	Long head
G	Small head SW 4 mm
N	Small head SW 5 mm
F	Finger-tight
V	1200 bar
B	Bio
P	PEEK

The **type** gives some indication on the primary function, like a loop or a connection capillary.











The **material** indicates which raw material is used.

The **fitting** left/right indicate which fitting is used on both ends of the capillary.

At-a-glance color-coding keys

The color of your capillary will help you quickly identify the capillary id - see the chart to the right for reference.

Tip: As you move to smaller-volume, high efficiency columns, you'll want to use narrow id tubing, as opposed to the wider id tubing used for conventional HPLC instruments.

Color-coding key for Agilent capillary tubing		
Internal diameter in mm		Color code
0.015		Orange
0.025		Yellow
0.05		Beige
0.075		Black
0.1		Purple
0.12		Red
0.17		Green
0.20/0.25		Blue
0.3		Grey
0.50		Bone White

Agilent capillary supplies are made from a variety of top-quality materials to suit your labs every need

Stainless steel (SST):

good resistance to pitting corrosion

Stainless steel is ideal for most standard applications - except where bio-inertness is required, in which case we recommend PEEK-lined or bio-inert titanium capillaries. Agilent's 0.6 mm od flexible grade 316L stainless steel capillaries (chrome/nickel/molybdenum bearing grade) are also much easier to handle than conventional, rigid 1.6 mm od capillaries.

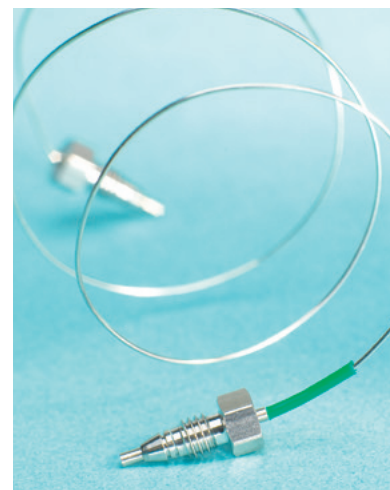

Titanium (Ti):

high inertness for biological applications

Analyzing metal-sensitive proteins and biotherapeutics presents challenging solvent conditions for LC instruments. In addition, biomolecules tend to bind nonspecifically to surfaces. For these reasons, bio-inert titanium is the best choice for these applications. Titanium is biocompatible, making bio-inert Titan capillaries perfect for applications where bio-inertness is paramount.

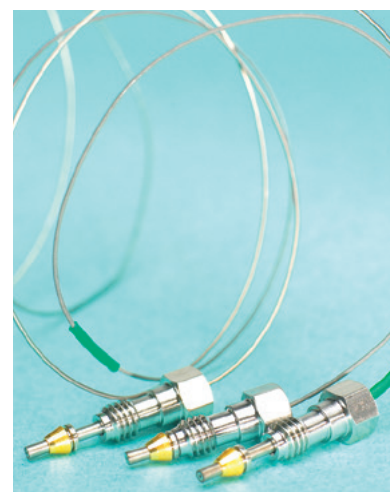



Stainless Steel-coated PEEK (PK/SST): high-pressure bio-inertness and robustness

In biochromatography, capillaries and connectors should be inert to ensure the lowest interaction with protein samples. They must also be highly robust to withstand harsh cleaning procedures.

Unfortunately, metal-free PEEK capillaries can only withstand pressures of up to 200 bar in a thermostatically controlled cabinet with acetonitrile; even then, flexibility is compromised. To meet the growing need for bio-inertness, robustness, and higher operating pressures, Agilent has engineered a bio-inert PEEK liner clad with high-strength stainless steel to withstand pressures of at least 600 bar. This same technology is used in Agilent capillary fittings - giving you a strong, metal-free, capillary/connector flow path for bio-inert applications.

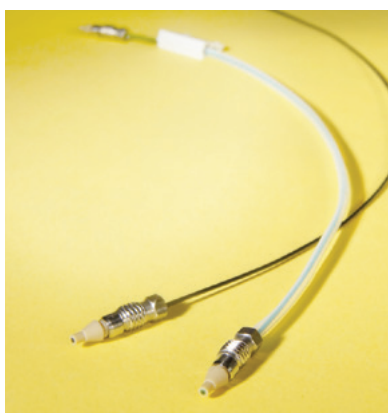

PEEK-coated fused silica (FS/PK): rugged and pliable

Since their introduction in the early 1980s, fused silica capillaries have become the industry standard for many GC and LC applications - as well as capillary electrophoresis. Agilent fused-silica capillaries are made from high-purity silicon dioxide, and coated with PEEK for strength, durability, and pliability.

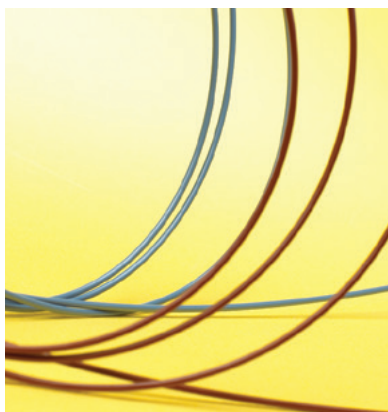

PEEK (PK): durable and abrasion-resistant

Agilent PEEK capillaries are best for standard and bio-inert applications. PEEK (polyetheretherketone) is a thermoplastic polymer that resists mechanical and solvent damage, even at high temperatures. Because it is less vulnerable to corrosion than stainless steel, PEEK can be used in place of stainless steel when the capillary's external diameter is 1/16 inch or less. It also resists abrasion, making it an excellent coating for fused silica capillaries.

Tip: Use our color-coded PEEK fittings to track inlets and outlets of valves, columns, and detectors.

To learn more about Agilent LC capillary supplies, or to order now, visit www.agilent.com/chem/LCcapillaries

Agilent capillaries for routine applications

Category	Applications	Internal diameter (mm)	Pressure limit (bar)	pH range	Comments
Stainless steel	<ul style="list-style-type: none"> All capillary applications, except where bio-inertness is required 1/32 inch od designed for Agilent 1100 systems 1/16 and 1/8 inch od for most applications 	0.075	1300	1-14	<ul style="list-style-type: none"> Flexible for easy routing Ready to use: cleaned and passivated to a high standard Precut capillaries are optimized for the lowest internal volume Use precut lengths to maintain zero-dead-volume performance
		0.12			
		0.17			
		0.25			
		0.3			
		0.5			
0.61					
0.93					
Titanium	<ul style="list-style-type: none"> Where ultimate bio-inertness is essential 	0.17 0.61	600	1-14	
Stainless-steel-coated PEEK	<ul style="list-style-type: none"> Universal for standard and bio-inert applications UHPLC bio-inert applications 	0.17	600	1-14	<ul style="list-style-type: none"> Metal-free flow path Robust Flexible Resists corrosion better than stainless steel
PEEK-coated fused silica	<ul style="list-style-type: none"> Industry standard for most LC applications 	0.025	690	1-10	<ul style="list-style-type: none"> Mechanically strong Consistent, rigid flow path Ideal replacement for stainless steel To avoid permanent tube damage, always use precut lengths
		0.050			
		0.075			
		0.100			
		0.125			
PEEK	<ul style="list-style-type: none"> Most HPLC applications 	0.13	480* 200**	1-14	<ul style="list-style-type: none"> Smooth internal surface minimizes turbulence for improved resolution Flexible, easily cut to length Use with PEEK or stainless steel fittings Excellent solvent compatibility
		0.18			
		0.25			
		0.50			

*At ambient temperature with water

**With acetonitrile at non-ambient temperature



Fittings for a strong, capillary flow path

Agilent offers more than 20 fitting varieties for Swagelok-type or metric M4/M3-type connections. Depending on your application, different materials must be used:

- Stainless steel or PEEK delivers permanent high-pressure sealing performance for connections such as valves, heaters, and columns
- Stainless steel ensures permanent high-pressure sealing and optimal performance throughout your LC system up to 1200 bar
- Finger-tight fittings (polymeric for 400 bar and polyketone for 600 bar) are a convenient option; They allow easy end fitting adjustment, so you can seat the capillary into the column properly, preventing extracolumn voids and leaks
- High-pressure fittings, which can be used with pressures up to 1200 bar, can be removed and replaced
- It is a good idea to use stainless steel nuts and ferrules for instrument connections, and PEEK nuts and ferrules for column and guard column connections, since these are changed most frequently

Agilent Fittings for Leak-Free Connections

Fitting type	Advantages/tips
InfinityLab Quick Connect fitting	<ul style="list-style-type: none"> • Fast and easy connections • Finger-tight 1300 bar • Spring-loaded design for zero dead volume connections • Replaceable ferrule
InfinityLab Quick Turn fitting	<ul style="list-style-type: none"> • Finger-tight up to 400 bar, up to 1300 bar by using a wrench • Spring-loaded design for zero dead volume connections • Replaceable ferrule
Swagelok-type fittings	<ul style="list-style-type: none"> • Suitable for most connections • Available in a variety of combinations: • One piece or multiple pieces with nut + front and back ferrules • Stainless steel, PEEK, polyketone, or a stainless steel/PEEK combination
Metric M4/metric M3	<ul style="list-style-type: none"> • For micro valve connections
Stainless steel	<ul style="list-style-type: none"> • At least 1200 bar • Most popular material for permanent, high-pressure sealing • Use our slitted socket wrench (p/n 8710-2391 or p/n 5023-0240) for optimal tightness
PEEK	<ul style="list-style-type: none"> • Up to 400 bar (at ambient temperature with water) • Easy, finger-tight column connections • Ideal for frequently changed connections, such as column connections • Pressure is less critical
Polyketone	<ul style="list-style-type: none"> • < 600 bar (600 bar pressure rating) • Easy, finger-tight column connections • Fits stainless steel tubing

TIPS & TOOLS

Tips and tools for creating the best possible connections

See Page 125.

InfinityLab Quick Connect and Quick Turn fittings

Poorly connected fittings are one of the top reasons for broad or tailing peaks, loss of resolution, and overall poor chromatography. With Agilent InfinityLab Quick Connect fittings however, you can have complete confidence in your LC connections. The spring-loaded design, means that zero dead volume connections with LC columns are made as easily as pressing a lever. So no special training is needed, saving you time and trouble. InfinityLab Quick Connect fittings are long lasting, reseal tightly, and are stable up to 1300 bar (18,850 psi) even after 200+ reconnections. Which means they truly are reliable and reusable. Therefore, with InfinityLab Quick Connect fittings you can be sure that you are getting a perfect column connection, every time.

For harder to reach areas on your LC instrument, you can rely on InfinityLab Quick Turn fittings. Like the InfinityLab Quick Connect fittings, they use a proprietary spring-loaded design for zero dead volumes and a sure connection. Quick Turn fittings produce either a finger-tight connection (stable to 600 bar)—or a premium UHPLC connection (stable to 1300 bar) with a quick turn of the wrench.



Real stories from the lab.



TRUE STORY No. 7 ITS IN THE DETAILS

A lab manager initially resisted trying InfinityLab fittings because they cost more than traditional fittings. Then, a CrossLab expert helped him evaluate their true value for his lab.

Agilent
CrossLab
From Insight to Outcome

www.agilent.com/chem/story7

InfinityLab Quick Connect Assemblies

Description	Part No.
Stainless steel, 0.075 x 105 mm with a Quick Turn fitting	5067-6602
Stainless steel, 0.075 x 105 mm	5067-5961
Stainless steel, 0.075 x 150 mm	5067-6163
Stainless steel, 0.075 x 220 mm	5067-6164
Stainless steel, 0.075 x 280 mm	5067-6165
Stainless steel, 0.12 x 105 mm	5067-5957
Stainless steel, 0.12 x 150 mm	5067-5958
Stainless steel, 0.12 x 220 mm	5067-5959
Stainless steel, 0.12 x 280 mm	5067-5960
Stainless steel, 0.17 x 105 mm	5067-6166
Stainless steel, 0.17 x 150 mm	5067-6167
Stainless steel, 0.17 x 220 mm	5067-6168
Stainless steel, 0.17 x 280 mm	5067-6169
Stainless steel 0.25 mm x 105 mm with a female connection	5067-6210

Note: Each assembly is equipped with a capillary, a Quick Connect fitting or a Quick Turn fitting where specified, and a Swagelok fitting or a female connection where specified

DID YOU KNOW?

Agilent InfinityLab Poroshell 120 columns are available in 12 different chemistries across 3 particle sizes (1.9 μm , 2.7 μm , 4 μm), for maximum flexibility in method development and method transfer across all LC systems.

See **Pages 128–131** to learn more.

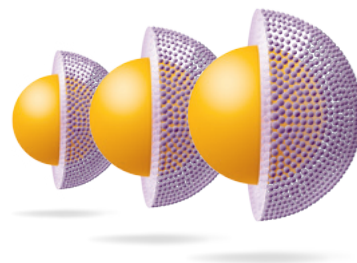

InfinityLab Quick Connect Fittings

Description	Part Number
Capillaries for InfinityLab Quick Connect fitting	
Capillary, stainless steel, 0.12 x 280 mm	5500-1170
Capillary, stainless steel, 0.12 x 220 mm	5500-1171
Capillary, stainless steel, 0.12 x 150 mm	5500-1172
Capillary, stainless steel, 0.12 x 105 mm	5500-1173
Capillary, stainless steel, 0.075 x 105 mm	5500-1174
Capillary, stainless steel, 0.075 x 150 mm	5500-1175
Capillary, stainless steel, 0.075 x 220 mm	5500-1176
Capillary, stainless steel, 0.075 x 250 mm	5500-1177
Capillary, stainless steel, 0.075 x 280 mm	5500-1178
Capillary, stainless steel, 0.12 x 400 mm	5500-1179
Capillary, stainless steel, 0.12 x 500 mm	5500-1180
Capillary, stainless steel, 0.17 x 105 mm	5500-1181
Capillary, stainless steel, 0.17 x 150 mm	5500-1182
Capillary, stainless steel, 0.17 x 220 mm	5500-1183
Capillary, stainless steel, 0.17 x 280 mm	5500-1230
Capillary, stainless steel, 0.17 x 500 mm	5500-1231
Capillary, stainless steel, 0.12 x 120 mm	5500-1247
Capillary, stainless steel, 0.17 x 120 mm	5500-1248
Capillary, stainless steel, 0.25 x 105 mm with a female connection	5500-1258
Capillary, stainless steel, 0.25 x 150 mm	5500-1259
Capillary, stainless steel, 0.25 x 400 mm	5500-1260
Capillary, stainless steel, 0.12 x 150 mm, M4	5500-1289
Capillary, stainless steel, 0.17 x 150 mm, M4	5500-1291
Fittings	
InfinityLab Quick Connect LC fitting	5067-5965
InfinityLab front ferrule	5043-0924

Note: The InfinityLab Quick Connect fitting can only be equipped with an InfinityLab capillary specified in this table. The InfinityLab capillary is designed with a spring and a holder.



InfinityLab Quick Connect LC fitting, 5067-5965

InfinityLab Quick Turn Fittings

Description	Part Number
Capillaries for InfinityLab Quick Turn fitting	
Capillary, stainless steel, 0.12 x 105 mm, long socket	5500-1188
Capillary, stainless steel, 0.12 x 150 mm, long socket	5500-1189
Capillary, stainless steel, 0.12 x 200 mm, long socket	5500-1190
Capillary, stainless steel, 0.12 x 280 mm, long socket	5500-1191
Capillary, stainless steel, 0.12 x 500 mm, long socket	5500-1192
Capillary, stainless steel, 0.17 x 105 mm, long socket	5500-1193
Capillary, stainless steel, 0.17 x 150 mm, long socket	5500-1194
Capillary, stainless steel, 0.17 x 200 mm, long socket	5500-1195
Capillary, stainless steel, 0.17 x 280 mm, long socket	5500-1196
Capillary, stainless steel, 0.17 x 500 mm, long socket	5500-1197
Capillary, stainless steel, 0.075 x 105 mm, long socket	5500-1198
Capillary, stainless steel, 0.12 x 130 mm, long socket, M4	5500-1200
Capillary, stainless steel, 0.075 x 500 mm, long socket	5500-1205
Capillary, stainless steel, 0.075 x 250 mm, long socket	5500-1206
Capillary, stainless steel, 0.075 x 150 mm, long socket	5500-1232
Capillary, stainless steel, 0.12 x 180 mm, long socket	5500-1233
Capillary, stainless steel, 0.17 x 180 mm, long socket	5500-1234
Capillary, stainless steel, 0.17 x 380 mm, long socket	5500-1235
Capillary, stainless steel, 0.17 x 400 mm, long socket	5500-1236
Capillary, stainless steel, 0.17 x 700 mm, long socket	5500-1237
Capillary, stainless steel, 0.25 x 105 mm, long socket with a female connection	5500-1261
Capillary, stainless steel, 0.25 x 150 mm, long socket	5500-1262
Capillary, stainless steel, 0.25 x 400 mm, long socket	5500-1263
Capillary, stainless steel, 0.12 x 150 long socket, M4	5500-1288
Capillary, stainless steel, 0.17 x 150 long socket, M4	5500-1290
Fittings	
InfinityLab Quick Turn LC fitting	5067-5966
InfinityLab front ferrule	5043-0924

Agilent 1260/1200/1100 Infinity Series System Capillaries

From (A)	To (B)	Material	ID (mm)	Length (mm)	Fitting Type From	Fitting Type To	Notes	Part No.
Pump	Autosampler	SST	0.17	900	S	S	Preswaged on A	G1329-87300
Pump	Autosampler	SST	0.17	700	S	S	Preswaged on A and B	G1312-87304
Pump	Autosampler	SST	0.17	600	S	S	Preswaged on A	G1312-67305
Pump	Autosampler	SST	0.17	400	S	S	Preswaged on A and B	G1312-87303
Pump	Autosampler	SST	0.17	380	S	S	Preswaged on A and B	01090-87306
Manual injector	Column	SST	0.17	180	S	S	Preswaged on A	G1313-87305
Manual Injector	TCC	SST	0.17	500	SH	S	Nonswaged on A and B	G1328-87600
Heater	Column	SST	0.17	90	S	S	Nonswaged on A and B	G1316-87300
Column	Detector	SST	0.17	380	S	S	Preswaged on A; thermal isolation	G1315-87311
TCC\VWD	MS	SST	0.12	500	S	S	Preswaged on A	G1316-87309
Column	VWD	PK	0.17	600			Finger-tight fittings not included (0100-1516, 2/pk)	5062-8522
Pump Purge Valve	Waste	PTFE	1.3	5000*			No fitting needed	5062-2461
Detector	Waste	PTFE	0.8	5000*			Finger-tight fittings not included (0100-1516, 2/pk)	5062-2462
VWD	Waste	PK	0.25	500			Finger-tight fittings not included (0100-1516, 2/pk)	5062-8535
Autosampler	TCC	SST	0.12	180	S	S	Preswaged on A; can also be connected to low dispersion heat exchanger	G1313-87304
Thermostatted Autosampler	TCC	SST	0.12	280	S	S	Preswaged on A; can also be connected to low dispersion heat exchanger	01090-87610
TCC	Column	SST	0.12	105	S	S	Preswaged on A	01090-87611
Column	DAD	SST	0.12	150	S	S	Preswaged on A	G1315-87312
Female adapter for connecting long columns		SST	0.17	150	S		In addition to G1315-87311	G1315-87303

*Capillary is intended to be cut to the right length for your need.

**Calibration capillary assembly

Material

Key	Description
SST	Stainless steel
PK	PEEK
PTFE	PTFE
FS	Fused silica
S	Swagelok 1.6 mm port id
SL	Swagelok 1.6 mm port id, long
SH	Swagelok 1.6 mm port id, long head
U	Female Swagelok fitting
M	Metric M4 0.8 mm port id

LC CAPILLARIES



Finger-tight PEEK fitting (SPF), 0100-1516



Stainless steel fittings (S), 5062-2418



Stainless steel back ferrule, 5180-4114



Stainless steel fittings (S), 5062-2418



Finger-tight PEEK fitting (SPF), 0100-1516



PEEK fittings, plugs (MP), 5065-4410

Material

Key	Description
SST	Stainless steel
S	Swagelok 1.6 mm port id
PK	PEEK
PTFE	PTFE

Agilent 1290 Infinity Series System Capillaries

From (A)	To (B)	Material	ID (mm)	Length (mm)	Fitting Type From	Fitting Type To	Notes	Part No.
Pump	Autosampler	SST	0.17	300	S	S	Preswaged on A and B	5067-4657
Pump	Thermostatted autosampler	SST	0.17	450	S	S	Preswaged on A and B	5067-4658
Autosampler	TCC	SST	0.12	340	S	S	Preswaged on A	5067-4659
Column	DAD	SST	0.12	220	S	S	Preswaged on A	5067-4660
1290 System	CTC Autosampler	SST	0.17	600	S	SH	Preswaged on A	5067-4670
CTC Autosampler	Column	SST	0.12	600	S	SL	Nonswaged on A and B	5067-4669
Detector	Waste	PTFE	0.8	5000*			Finger-tight fittings not included (0100-1516, 2/pk)	5062-2462

Agilent 1200 and 1100 Preparative LC Systems

From	To	Material	ID (mm)	Length (mm)	Fitting Type From	Fitting Type To	Notes	Part No.
Preparative isocratic	Autosampler	SST	0.6 mm	400 mm	S	S	Preswaged on A and B	G1361-67302
Autosampler	Column	SST	0.5 mm	600 mm	S	S/SX		G2260-87300
Autosampler	Column	SST	0.5 mm	400 mm	S	SH		G2260-87301

Agilent 1220/1120 Infinity Series LC

From	To	Material	ID (mm)	Length (mm)	Fitting Type From	Fitting Type To	Notes	Part No.
Pump	Autosampler	SST	0.17 mm	380 mm	S	S	Preswaged on A and B	01090-87306
Manual injector	Column	SST	0.17 mm	180 mm	S	S	Preswaged on A	G1313-87305
Heater	Column	SST	0.17 mm	90 mm	S	S	Nonswaged on A and B	G1316-87300
Column	Detector	SST	0.17 mm	380 mm	S	S	Preswaged on A; thermal isolation	G1315-87311
VWD	Waste	PK	0.25 mm	500 mm			Finger-tight fittings not included (0100-1516, 2/pk)	5062-8535
Detector	Waste	PTFE	0.8 mm	5000 mm			Finger-tight fittings not included (0100-1516, 2/pk)	5062-2462

1260 Infinity II System Capillaries

From (A)	To (B)	Material	ID (mm)	Length (mm)	Fitting Type From	Fitting Type To	Notes	Part No.
Pump	Vi sampler/ Multisampler	SST	0.17	500	SI	SI	Preswaged on A and B	5500-1246
Multisampler	Multi column compartment							
Pump	Vi sampler (with ICC) Multisampler (dual stack configuration)	SST	0.17	900	SI	SI	Preswaged Dual stack configuration	5500-1217
Multisampler	Multi column compartment	SST	0.12	500	SL	SI	Preswaged on A and B	5500-1157
Vi sampler	Integrated column compartment	SST	0.17	105	SL	SL	Preswaged on A and B	5500-1240
Integrated column compartment	Column	SST	0.17	120	SL	SL	Preswaged on A	5500-1250
Column	DAD	SST	0.12	280				5500-1191
Column	VWD	PK	0.17	600				5062-8522

1290 Infinity II System Capillaries

From (A)	To (B)	Material	ID (mm)	Length (mm)	Fitting Type From	Fitting Type To	Notes	Part No.
Pump	Sampler	SST	0.17	500	SI	SI		5500-1246
Pump	Vi sampler with ICC	SST	0.17	900	SI	SI		5500-1217
Multisampler	Multi column compartment	SST	0.12	500	SL	SI	Preswaged on A and B	5500-1157
Vi sampler	Integrated column compartment	SST	0.12	105	SL	SL	Preswaged on A and B	5500-1238
Integrated Column Compartment	Column	SST	0.12	120	SL	SL	Preswaged on A	5500-1249
Column	DAD	SST	0.12	280				5500-1191
Column	VWD	PK	0.17	600				5062-8522

Note: For column connect capillaries check for the InfinityLab fittings and capillaries on **Pages 103–106**

Agilent Infinity 1260 Bio-inert LC System Capillaries

From (A)	To (B)	Material	id (mm)	Length (mm)	Fitting Type (A)	Fitting Type (B)	Notes	Part No.
Autosampler injection valve	Heat exchanger/column	PK/SST	0.17	400	RLO	RLO	Nonswaged	G5667-81004
Manual injection valve	Heat exchanger/column	PK/SST	0.17	500	RLO	RLO	Nonswaged	G5667-81005
Autosampler injection valve	Autosampler analytical head	Ti	0.17	160	SLB	SV	Preswaged on A	G5611-60503
Damper	Pump head	Ti	0.6	234	SLB	SLB	For pump only. Preswaged on A and B	G5611-67301
Outlet ball valve	Damper	Ti	0.6	248	SLB	SLB	For pump only. Preswaged on A and B	G5611-67300
		PK/SST	0.17	105	SLB	SLB	Nonswaged	G5667-81000
		PK/SST	0.17	150	SLB	SLB	Nonswaged	G5667-81001
		PK/SST	0.17	200	SLB	SLB	Nonswaged	G5667-81002
		PK/SST	0.17	300	SLB	SLB	Nonswaged	G5667-81003
		PK/SST	0.17	400	SLB	SLB	Nonswaged	G5667-81004

Material

Key	Description
SST	Stainless steel
PK	PEEK
PK/SST	PEEK and stainless steel
Ti	Titanium
S	Swagelok 1.6 mm port id
U	Female Swagelok fitting
SI	Swagelok 1.6 mm port id, intermediate
SL	Swagelok 1.6 mm port id, long
SLB	Swagelok 1.6 mm port id, long bio
SV	Swagelok 1.6 mm port id, 1200 bar
SLV	Swagelok 1.6 mm port id, long, 1200 bar
SX	Swagelok 1.6 mm port id, extra-long
RLO	UHP-FF fitting, bio-inert



Titanium fitting (SLB), G5611-60502



Capillary, PK/SST, G5667-81000

Agilent Infinity II 1260 Bio-inert LC System Capillaries

From (A)	To (B)	Material	id (mm)	Length (mm)	Fitting Type (A)	Fitting Type (B)	Notes	Part No.
Pump	Multisampler	Ti	0.17	500	SLB	SLV		5500-1264
Multisampler	Heat exchanger/ column	PK/SST	0.17	500	RLO	RLO	Nonswaged	G5667-81005
Manual injector valve								
Column selection valve	Column (if not using heat exchanger)	PK/SST	0.17	280				5500-1276*
Multisampler	Column (if not using heat exchanger)	PK/SST	0.17	500				5500-1277*
Column thermostat/ column	Detector	PK	0.18	1500			Nonswaged	0890-1763
Detector	Fraction collector	PTFE-ESD	0.25					G5664-68712
Damper	Pump head	Ti	0.6	234	SLB	SLB	For pump only. Preswaged on A and B	G5611-67301
Outlet ball valve	Damper	Ti	0.6	248	SLB	SLB	For pump only. Preswaged on A and B	G5611-67300
		PK/SST	0.17	105	RLO	RLO	Nonswaged	G5667-81000
		PK/SST	0.17	150	RLO	RLO	Nonswaged	G5667-81001
		PK/SST	0.17	200	RLO	RLO	Nonswaged	G5667-81002
		PK/SST	0.17	300	RLO	RLO	Nonswaged	G5667-81003
		PK/SST	0.17	400	RLO	RLO	Nonswaged	G5667-81004

*For use with InfinityLab Quick Connect fitting at one end

TIPS & TOOLS

For more information on bio-inert capillaries and fittings, enter 5991-7469EN at www.agilent.com/search



UHP-FF fitting, bio-inert (RLO), 5067-5695

Stainless Steel Capillaries with Fittings

Material	id (mm)	Length (mm)	Fitting Type From (A)	Fitting Type To (B)	od (mm) A*	od (mm) B*	Notes	Part No.
SST	0.12	50	S	U	1.6			G1316-87312
SST	0.12	60	S	S	1.6	1.6	Preswaged on A and B	79841-87610
SST	0.12	70	S	S	1.6	1.6		G1316-87303
SST	0.12	70	S	U	1.6			G1316-87313
SST	0.12	75	S	M	1.6	0.8		G1316-87306
SST	0.12	90	S	U	1.6			G1316-87314
SST	0.12	90	S	SX	1.6	1.6		5067-4685
SST	0.12	100	M	M	0.8	0.8		G1316-27301
SST	0.12	120	SX	SX	1.6	1.6		5067-4688
SST	0.12	170	S	S	1.6	1.6		G1316-87316
SST	0.12	170	S	M	1.6	0.8	Preswaged on A and B	5500-1270
SST	0.12	210	S	S	1.6	1.6		G1316-87317
SST	0.12	300	S	S	1.6	1.6		G1316-87318
SST	0.12	340	S	S	1.6	1.6		G1316-87319
SST	0.12	340	S	M	1.6	0.8	Preswaged on A	G1316-87305
SST	0.12	340	SL	M	1.6	0.8	Preswaged on B	5500-1286
SST	0.12	500	M	M	0.8	0.8	Preswaged on A and B	5500-1305
SST	0.12	700	M	M	0.8	0.8	Preswaged on A and B	5500-1306
SST	0.12	2000	U	U			Restriction capillary	5022-2159
SST	0.17	105	S	S	1.6	1.6		G1316-87321
SST	0.17	105	S	S	1.6	1.6	Preswaged on A and B	G1312-87306
SST	0.17	150	S	S	1.6	1.6	Preswaged on A and B	G1312-87305
SST	0.17	150	M	M	0.8	0.8		5067-4737
SST	0.17	170	S	S	1.6	1.6		G1316-87323
SST	0.17	250	S	S	1.6	1.6	Preswaged on A and B	G1367-87304
SST	0.17	280	S	S	1.6	1.6	Preswaged on A	01090-87304
SST	0.17	280	SX	S	1.6	1.6	Preswaged on A and B	5067-4608
SST	0.17	280	SX	SX	1.6	1.6	Preswaged on A and B	5067-4607
SST	0.17	280	SX	S	1.6	1.6	Preswaged on A and B	5067-4608
SST	0.17	500	SX	SH	1.6	1.6	Preswaged on A	5067-4609
SST	0.17	500	M	M	0.8	0.8	Preswaged on A and B	5500-1346
SST	0.17	700	S	SX	1.6	1.6	Preswaged on A and B	5067-4648
SST	0.17	700	M	M	0.8	0.8	Preswaged on A and B	5500-1347
SST	0.17	700	SL	M	1.6	0.8	Preswaged on A	5067-5120
SST	0.17	800	S	S	1.6	1.6	Preswaged on A	01048-87302
SST	0.17	800	SL	S	1.6	1.6	Preswaged on A	01078-87305

*1.6 mm = 1/16 in

Stainless Steel Capillaries without Fittings

Material	id (mm)	Length (mm)	od (mm) A*	od (mm) B*	Part No.
SST	0.12	105	1.6	1.6	5021-1820
SST	0.12	150	1.6	1.6	5021-1821
SST	0.12	200	1.6	1.6	5065-9935
SST	0.12	280	1.6	1.6	5021-1822
SST	0.12	400	1.6	1.6	5021-1823
SST	0.12	500	1.6	1.6	5065-9964
SST	0.17	105	1.6	1.6	5021-1816
SST	0.17	150	1.6	1.6	5021-1817
SST	0.17	200	1.6	1.6	5065-9931
SST	0.17	280	1.6	1.6	5021-1818
SST	0.17	400	1.6	1.6	5021-1819
SST	0.17	400	1.6	1.6	5021-1819
SST	0.17	600	1.6	1.6	5065-9933
SST	0.17	700	1.6	1.6	5065-9932
SST	0.17	900	1.6	1.6	5065-9963

*1.6 mm = 1/16 in

TIPS & TOOLS**Agilent LC Handbook****Your complete guide to method development and more**

Developed through the combined efforts of experienced Agilent chromatographers, the Agilent LC Handbook is filled with tips and tricks to help you succeed with HPLC column selection and method development. Now updated with chapters on LC and LC/MS.

Download now at www.agilent.com/chem/lc_handbook



Capillary Kits

Capillary and Fittings Kits

Description	Contents	Part No.
InfinityLab capillary kit, for 1260 Infinity II	Kit includes:	5067-6614
	ZDV union, stainless steel, 2/pk	
	Tubing, PTFE, 0.7 mm id, 1.6 mm od, 5 m	
	Fitting, PEEK, finger-tight, 1/16 inch, mixed colors, 10/pk	
	Capillary, stainless steel, 0.12 x 280 mm, 2/pk	
	Quick Connect assembly, stainless steel, 0.17 x 105 mm	
	Capillary, stainless steel, 0.17 x 105 mm	
	Quick Turn fitting	
	Replacement ferrule, for Quick Connect/Quick Turn fitting, 5/pk	
	Capillary, stainless steel, 0.17 x 500 mm, 2/pk	
	Capillary, stainless steel, 0.17 x 900 mm	
	Capillary, stainless steel, 0.17 x 120 mm	
	Blank nut, PEEK, with stainless steel core	
	Capillary, stainless steel, 2 m, 0.12 mm id, ferrule	
InfinityLab capillary kit, for 1290 Infinity II	Kit includes:	5067-6615
	ZDV union, stainless steel, 2/pk	
	Tubing, PTFE, 0.7 mm id, 1.6 mm od, 5 m	
	Fitting, PEEK, finger-tight, 1/16 inch, mixed colors, 10/pk	
	Stainless steel capillary, 0.12 x 280 mm, 2/pk	
	InfinityLab Quick Connect assembly, stainless steel, 0.12 x 105 mm	
	Capillary, stainless steel, 0.12 x 105 mm	
	InfinityLab Quick Turn fitting	
	Replacement ferrule, for InfinityLab Quick Connect/Quick Turn fitting, 5/pk	
	Capillary, stainless steel, 0.17 x 300 mm, 2/pk	
	Capillary, stainless steel, 0.17 x 900 mm	
	Capillary, stainless steel, 0.12 x 120 mm	
	Capillary, stainless steel, 0.12 x 500 mm	
	Blank nut, PEEK, with stainless steel core	
Capillary, stainless steel, 0.12 mm id, 2 m, ferrule		

(Continued)

Capillary and Fittings Kits

Description	Contents	Part No.
Bio-inert capillary kit, for 1260 Infinity II	Kit includes: Capillary, titanium, 0.17 x 500 mm, SL-SLV Capillary, PEEK/stainless steel, 0.17 x 500 mm Capillary, PEEK/stainless steel, 0.17 x 300 mm, RLO/RLO BIO Quick Connect fitting, standalone Union, bio-inert, 2/pk Front ferrule, 5/pk Blank nut, long 10-32 Tubing, PEEK, 0.18 mm, 5 m Fittings, colored, finger-tight, PEEK, 10/pk Mounting tool for UHP-FF fitting UHP-FF fitting, 2/pk	5067-6621
Capillary/fitting starter kit, for 1100 Capillary LC System multi-use kit, a collection of various capillaries and tools for use in the lab	Kit includes: Capillary, fused silica/PEEK, 50 µm, 55 cm, 2/pk Capillary, fused silica/PEEK, 50 µm, 20 cm Capillary, fused silica/PEEK, 100 µm, 110 cm Capillary, fused silica/PEEK, 50 µm, 50 cm, 2/pk Capillary, fused silica/PEEK, 50 µm, 40 cm, 2/pk Fitting, male 10-32, stainless steel, 4 mm, 4/pk Ferrule, PEEK, 1/32 inch, and lock ring, stainless steel, 4/pk Fittings, PEEK, for µ-valves, 4/pk Nuts, double winged, PEEK, and ferrules, 1/32 inch, 4/pk Cybertool	5065-9938

(Continued)



Cybertool

Capillary and Fittings Kits

Description	Contents	Part No.
Capillary/fitting starter kit, 0.12 mm id multi-use kit, a collection of various capillaries and tools for use in the lab	Kit includes:	5065-9937
	Capillary, PEEK, 0.13 mm id, 1.5 m	
	Capillary, stainless steel, 0.12 x 105 mm, 4/pk	
	Capillary, stainless steel, 0.12 x 150 mm, 4/pk	
	Capillary, stainless steel, 0.12 x 170 mm, 2/pk	
	Capillary, stainless steel, 0.12 x 200 mm, 2/pk	
	Capillary, stainless steel, 0.12 x 220 mm, 2/pk	
	Capillary, stainless steel, 0.12 x 280 mm, 2/pk	
	Capillary, stainless steel, 0.12 x 400 mm	
	ZDV union, stainless steel, 3/pk	
	Tubing cutter, for PEEK capillaries	
	Fittings, stainless steel, 1/16 inch, 10/pk	
	Fittings, PEEK, color, 1/16 inch, 10/pk	
	Fittings, PEEK, 1/16 inch, 10/pk	
Rheotool		
Cybertool		
Capillary/fitting starter kit, 0.17 mm id multi-use kit, a collection of various capillaries and tools for use in the lab	Kit includes:	5065-9939
	Capillary, PEEK, 0.18 mm id, 1.5 m	
	Capillary, stainless steel, 0.17 x 105 mm, 4/pk	
	Capillary, stainless steel, 0.17 x 150 mm, 4/pk	
	Capillary, stainless steel, 0.17 x 200 mm, 2/pk	
	Capillary, stainless steel, 0.17 x 280 mm, 2/pk	
	Capillary, stainless steel, 0.17 x 400 mm	
	ZDV union, stainless steel, 3/pk	
	Tubing cutter, for PEEK capillaries	
	Fittings, stainless steel, 1/16 inch, 10/pk	
	Fittings, PEEK, color, 1/16 inch, 10/pk	
	Fittings, PEEK, 1/16 inch, 10/pk	
	Rheotool	
	Cybertool	



Capillary/fitting starter kit 0.17 mm id, 5065-9939

PEEK-coated Fused Silica Capillaries

PEEK-coated Fused Silica Capillaries for Nano LC

From (A)	To (B)	Material	id (µm)	Length (mm)	Fitting Type From	Fitting Type To	Part No.
Switching valve	Column	FS/PEEK	25	100	MP	WPF	G1375-87320
EMPV	Flow sensor	FS/PEEK	25	220	WG	MP/WG	G1375-87321
Flow sensor	Injection valve	FS/PEEK	25	350	MP/WG	MP	G1375-87322
Switching valve	Column	FS/PEEK	25	550	MP	WPF	G1375-87323
Switching valve	Column	FS/PEEK	25	700	MP	WPF	G1375-87324
Switching valve	Column	FS/PEEK	50	100	MP	WPF	G1375-87325
Injection valve	Injector seat / second pump	FS/PEEK	75	650	MP	WG/WPF	G1375-87327

PEEK-coated Fused Silica Capillaries – 20 µL/min Flow

From (A)	To (B)	Material	id (µm)	Length (mm)	Fitting Type From	Fitting Type To	Part No.
EMPV	Flow sensor	FS/PEEK	50	220	WG	WG	G1375-87301
Flow sensor	Injection valve	FS/PEEK	50	550	WG	MP	G1375-87310
Injection valve	Metering device	FS/PEEK	50	200	MP	WG	G1375-87302
Injection valve	Column	FS/PEEK	50	500	MP	WPF	G1375-87304
Column	Detector	FS/PEEK	50	400	WPF		G1315-68703
Detector	Waste	FS/PEEK	75	700	SG	WPF	G1315-68708
Microswitching valve	Column	FS/PEEK	50	280	MP	WPF	G1375-87309
		FS/PEEK	50	700			G1375-87319

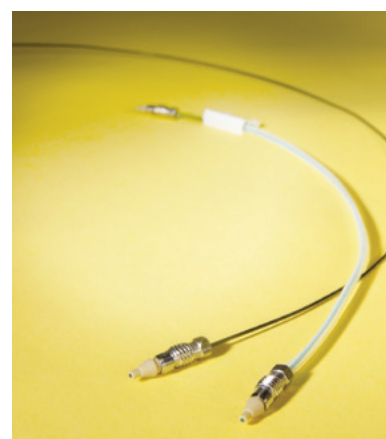

PEEK-coated Fused Silica Capillaries – 100 µL/min Flow

From (A)	To (B)	Material	id (µm)	Length	Fitting Type From	Fitting Type To	Part No.
EMPV	Flow sensor	FS/PEEK	100	220	WG	WG	G1375-87305
Flow sensor	Injection valve	FS/PEEK	100	550	WG	MP	G1375-87306
Injection valve	Metering device	FS/PEEK	100	200	MP	WG	G1375-87312
Injection valve	Column	FS/PEEK	75	500	MP	WPF	G1375-87311
Column	Detector	FS/PEEK	75	400	WPF		G1375-87308
Detector	Waste	FS/PEEK	75	700			G1315-68708
Microswitching valve	Column	FS/PEEK	50	280	MP	WPF	G1375-87309

Material

Key	Description
FS/PEEK	Fused silica/PEEK
W	Swagelok 0.8 mm port id
WG	Swagelok 0.8 mm port id, small head SW 4 mm
MP	Metric M4 0.8 mm port id, PEEK
WPF	Swagelok 0.8 mm port id, PEEK, finger-tight



Stainless steel screw, 5063-6593



PEEK fittings, plugs (MP), 5065-4410

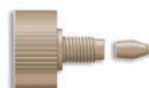

Double winged PEEK nut & ferrule (WPF), 5065-4422



Ferrule and stainless steel lock ring (W), 5065-4423

Tubing

PEEK Tubing

- Flexible and easy to cut to desired lengths
- Color coded for easy tracking
- Accepts both stainless steel and PEEK fittings
- 1/16 inch (1.6 mm) od



Tubing, PEEK, 0890-1762

PEEK Tubing

Description	Length	Color Code	Part No.
0.5 mm	1.5 m	Bone white	0890-1761
0.25 mm	1.5 m	Blue	0890-1762
0.25 mm	5 m	Blue	5042-6463
0.18 mm	1.5 m	Green	0890-1763
0.18 mm	5 m	Green	5042-6462
0.13 mm	1.5 m	Red	0890-1915
0.13 mm	5 m	Red	5042-6461

Other Tubing

Description	Length (m)	id (mm)	od (mm)	Part No.
Tubing, PTFE, FEP, primary use for valve solutions	5 m	0.7 mm	1.6 mm	5062-2462
Solvent tubing, PTFE, primary use for flow path from solvent bottle to degasser, to pump	5 m	1.5 mm	3.1 mm	5062-2483
Corrugated tubing, polypropylene	5 m	6.5 mm		5062-2463
Silicone tubing	5 m	1 mm	3 mm	5065-9978
Clamps and micro clamps, 10/pk				5065-9976
Barbed Y-connector PP for 3/16 in id tube, 10/pk				5065-9971

(Continued)



Tubing, PTFE, 5062-2462

Other Tubing

Description	Length (m)	id (mm)	od(mm)	Part No.
For G2258A 1100/1200 Series Dual Loop Autosampler				
Front seat tube, stainless steel	0.1 m	0.5 mm		G2258-87316
Back seat tube, stainless steel	0.12 m	0.5 mm		G2258-87315
Front seat tube, PTFE	0.1 m	0.2 mm		G2258-87312
Back seat tube, PTFE	0.12 m	0.25 mm		G2258-87313
Waste tube	0.15 m	0.8 mm		G2258-87310
Drawing tube assembly for flush solvent				G2258-87307
Tubing assembly, solvent flush				G2258-87314
For G1313/27/29A 1100/1200 Series Autosampler				
Waste tube				G1313-87300
Corrugated tubing, polypropylene	5 m	6.5 mm		5062-2463
For G1387A 1100/1200 Series Micro Autosampler				
Waste tube, FEP		0.8 mm	1.6 mm	G1375-87326

Accessories

Description	Part No.
Plastic tubing cutter	8710-1930
Blades for plastic cutter, 5/pk	8710-1931
Fitting screws, stainless steel, 10-32, 4 mm, 5/pk	5065-9948
Ferrule, PEEK, and stainless steel ring, for 2.0 mm tube, 5/pk	5065-9950
Union, PEEK for 1/8 in od tubing	0100-2410
Waste adapter, 1200 Series autosamplers, gray	G1313-43216



Plastic tubing cutter, 8710-1930



Fitting screws, 5065-9948



PEEK ferrules and stainless steel rings, 5065-9950

Fittings and Unions

Fittings

Description	Key	Unit	Part No.
InfinityLab Quick Turn LC fitting			5067-5966
InfinityLab Quick Connect LC fitting			5067-5965
InfinityLab front ferrule			5043-0924
Swagelok, 1.6 mm, stainless steel fitting	S	10/pk	5062-2418
Swagelok, 1.6 mm, stainless steel fitting, long screw	SL	10/pk	5065-4454
Swagelok, 1.6 mm, stainless steel fitting, extra long screw	SX	10/pk	5065-9967
Swagelok, 1.6 mm, screw		10/pk	5061-3303
Front ferrule, stainless steel, 1.6 mm		10/pk	5180-4108
Back ferrule, stainless steel, 1.6 mm		10/pk	5180-4114
Swagelok, 1.6 mm, 1200 bar, removable fitting	SV		5067-4733
Swagelok, 1.6 mm, 1200 bar, removable fitting, long screw	SLV		5067-4738
Swagelok, 1.6 mm, 1200 bar, removable fitting, extra long screw	SXV		5067-4739

(Continued)

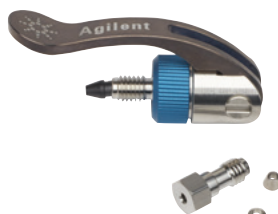

InfinityLab Quick Connect LC fitting, 5067-5965



Stainless steel fittings (S), 5062-2418



Stainless steel long fittings (SL), 5065-4454



Stainless steel extra long fitting (SX), 5065-9967



Stainless steel front ferrules, 5180-4108



Stainless steel back ferrule, 5180-4114



1200 bar removable fitting (SV), 5067-4733



1200 bar removable long fitting (SLV), 5067-4738



1200 bar removable extra long fitting (SXV), 5067-4739

Material

Key	Description
S	Swagelok 1.6 mm port id
SL	Swagelok 1.6 mm port id, long
SX	Swagelok 1.6 mm port id, extra-long
SV	Swagelok 1.6 mm port id, 1200 bar
SLV	Swagelok 1.6 mm port id, long, 1200 bar
SXV	Swagelok 1.6 mm port id, extra-long, 1200 bar
SPF	Swagelok 1.6 mm port id, PEEK, finger-tight
SPLF	Swagelok 1.6 mm port id, PEEK, long, finger-tight



PEEK fittings (SPF),
0100-1516/5063-6591



Finger-tight PEEK fitting (SPF),
0100-1516

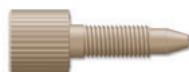

PEEK long fittings (SPFL), 5062-8541



Finger-tight PEEK fittings (SPF),
5065-4426



Double winged fitting (SPF),
5042-6500

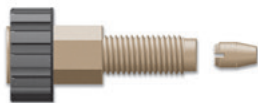

PEEK RheFlex fittings (SPF),
0100-1631



PEEK RheFlex fittings (SPF),
0100-2175



Stainless steel blanking nut,
01080-83202



Blanking nut, stainless steel,
for M4 fittings ports, 5067-6141



Blank nut long, 10-32, PEEK/stainless
steel, 5043-0277

Fittings

Description	Key	Unit	Part No.
Swagelok, 1.6 mm, PEEK, finger-tight fitting	SPF	10/pk	5063-6591
Swagelok, 1.6 mm, PEEK, finger-tight fitting	SPF	2/pk	0100-1516
Swagelok, 1.6 mm, PEEK, long, finger-tight fitting	SPLF	10/pk	5062-8541
Swagelok, 1.6 mm, PEEK, finger-tight fitting (mixed colors)	SPF	10/pk	5065-4426
Swagelok, 1.6 mm, PEEK, finger-tight, double winged fitting	SPF	10/pk	5042-6500
Swagelok, 1.6 mm, PEEK, finger-tight, RheFlex fitting	SPF	5/pk	0100-1631
Swagelok, 1.6 mm, PEEK, finger-tight, RheFlex fitting (mixed colors)	SPF	10/pk	0100-2175
Swagelok, 1.6 mm, stainless steel blanking nut			01080-83202
Blanking nut, stainless steel, for M4 fittings ports			5067-6141
Blanking nut, long, 10-32, PEEK with stainless steel core, finger-tight			5043-0277

Fittings

Description	Key	Unit	Part No.
Swagelok, 1.6 mm, stainless steel screw, for PEEK ferrule 5067-1547	S	6/pk	5067-1540
Ferrule, PEEK, 1.6 mm, for screw 5067-1540	SP	6/pk	5067-1547
Swagelok, 1.6 mm, finger-tight polyketone fitting	SPF	10/pk	5042-8957
M4 stainless steel screw, for stainless steel ferrule 5067-1557	M	6/pk	5067-1558
Ferrule, stainless steel, 0.8 mm, for 5067-1558 screw	M	6/pk	5067-1557
Swagelok 1.6 mm plastic blank nut	M		0100-1259
Swagelok 1.6 mm stainless steel screw, 4 mm head	G	10/pk	5063-6593
Ferrule, PEEK, 0.8 mm, and stainless steel ring, for screw 5063-6593	W	10/pk	5065-4423
M4 fitting, PEEK, 0.8 mm	MP	6 fittings, 2 plugs	5065-4410
Swagelok 0.8 mm finger-tight PEEK double winged fitting	WPF	10/pk	5065-4422
Swagelok 0.8 mm finger-tight PEEK long fitting	WPFL		5022-6536
Swagelok 2.0 mm stainless steel screw, 4 mm head		5/pk	5065-9948
Ferrule, PEEK, and stainless steel ring, for 2.0 mm tube		5/pk	5065-9950

Material

Key	Description
S	Swagelok 1.6 mm port id
SL	Swagelok 1.6 mm port id, long
SX	Swagelok 1.6 mm port id, extra-long
SV	Swagelok 1.6 mm port id, 1200 bar
SLV	Swagelok 1.6 mm port id, long, 1200 bar
SXV	Swagelok 1.6 mm port id, extra-long, 1200 bar
SPF	Swagelok 1.6 mm port id, PEEK, finger-tight
SPLF	Swagelok 1.6 mm port id, PEEK, long, finger-tight



Stainless steel nut and PEEK ferrule, 5067-1540



Ferrule and stainless steel lock ring (W), 5065-4423



PEEK ferrule, 5067-1547



PEEK fittings, plugs (MP), 5065-4410



Finger-tight polyketone fitting (SPF), 5042-8957



Double winged PEEK nut and ferrule (WPF), 5065-4422



M4 stainless steel screw, 5067-1558



PEEK fitting, long (WPFL), 5022-6536



Stainless steel ferrule (M), 5067-1557



Fitting screws, 5065-9948



Plastic blank nut, 0100-1259



Stainless steel screw, 5063-6593



PEEK ferrules and SS rings, 5065-9950



ZDV union, 5022-2145



Adapter, PEEK, 0100-2298



ZDV universal union, 5022-2184



Barbed Y-connector PP, 5065-9971



ZDV union with fittings, 0100-0900



Union, female to female, 5042-8517



ZDV union, PEEK with fittings, 0100-2441



High flow union, 5022-2133



Adapter, male Luer to female, 5042-8518



PEEK adapter, 0100-1847



Adapter, female to male, 5023-1803



Bio-inert union, 600 bar, 5067-4741

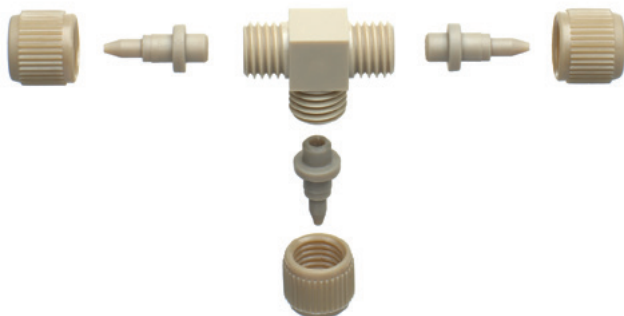

Micro T-connector, PEEK, 5042-8519

Unions

Description	Used With	Part No.
ZDV union, no fittings	Nano LC	5022-2145
ZDV universal union, stainless steel, no fittings	Standard LC	5022-2184
ZDV union, with fittings	Standard LC	0100-0900
ZDV union, PEEK with fittings	Bio-applications	0100-2441
High flow union, no fittings	Preparative LC	5022-2133
Adapter, PEEK, 1/4-28 to 10-32		0100-1847
Adapter, PEEK int. 1/4-28 to ext. 10-32		0100-2298
Barbed Y-connector PP for 3/16 in id tube, 10/pk		5065-9971
Adapter, female 10-32 to female 1/4-28		5042-8517
Adapter, male Luer to female 1/4-28		5042-8518
Adapter, stainless steel, Swagelok to 1/4-28		5023-1803
T-connector, PEEK, swept volume 0.57 µL	For 1/16 inch od tubing	5022-2144
Micro T-connector, PEEK, swept volume 29 nL, with 1/32 inch id fittings		5042-8519
Bio-inert union, stainless steel with PEEK insert 600 bar	Bio-applications	5067-4741

Tips and tools for creating the best possible connections

How do I tighten fittings correctly?

The chart below describes the steps you will need to follow.

Fitting type	First Connection	Further connection
InfinityLab Quick Connect fitting	<ol style="list-style-type: none"> 1. Insert capillary into the port and turn the blue ring until you feel the first resistance (overtightening will damage the fitting). 2. Close the lever. The connection is tight to 1300 bar. The InfinityLab Quick Connect LC fitting can be reconnected multiple times without loss of performance. 	<p>Follow the same steps again.</p> <p>Ferrule can be replaced in case of damage, see p/n 5043-0924.</p>
InfinityLab Quick Turn fitting	<ol style="list-style-type: none"> 1. Insert capillary into port and turn the fitting until finger-tight. Depending upon the required pressure, you can tighten the fitting an extra ¼ turn to ½ turn with a wrench. 	<p>Follow the same steps again.</p> <p>Ferrule can be replaced in case of damage, see p/n 5043-0924.</p>
Polymeric finger-tight: PEEK and polyketone	<ol style="list-style-type: none"> 1. Slide the screw and ferrule onto the capillary. 2. Insert capillary into the port until it is completely seated in the end fitting. 3. Finger-tighten the nut until the capillary does not rotate. 4. Make sure the capillary cannot be easily pulled out. 	<p>Additional tightening if necessary</p> <p>See good connections step by step</p>
Stainless steel	<ol style="list-style-type: none"> 1. Slide the screw, along with the back and front ferrules, onto the capillary. 2. Insert capillary into the port until it is completely seated in the end fitting. 3. Finger-tighten the nut until the capillary does not rotate. 4. Tighten the nut ½ to ¾ turn with a slitted socket wrench or Rheotool (p/n 8710-2391). If you are using a torque wrench, tightening torque should be between 1.5 and 3.0 Nm) 	<p>Finger-tighten, then tighten an extra ¼ to ½ turn with a slitted socket wrench or Rheotool (p/n 8710-2391). (If using a torque wrench, tightening torque should be between 1.5 and 3.0 Nm).</p>
1200 bar removable fitting	<ol style="list-style-type: none"> 1. Slide the screw, along with the back and front ferrules, onto the capillary. 2. Insert capillary into the port until it is completely seated in the end fitting. 3. Finger-tighten the nut until the capillary does not rotate. 4. Tighten the nut about ¾ turn with a socket wrench. 5. For stainless steel capillaries, if using a torque wrench, tightening torque should be between 1.0 and 1.2 Nm. 6. For stainless steel coated PEEK capillaries, do not exceed 0.8 Nm. 	<p>Finger-tighten, then tighten an extra ¼ to ½ turn with a socket wrench.</p> <p>For stainless steel capillaries, if using a torque wrench, tightening torque should be between 1.0 and 1.2 Nm.</p> <p>For stainless steel coated PEEK capillaries, if using a torque wrench, do not exceed 0.8 Nm.</p>
PEEK/stainless steel	<ol style="list-style-type: none"> 1. Slide the screw, along with the back and front ferrules, onto the capillary. 2. Insert capillary into the port until it is completely seated in the end fitting. 3. Finger-tighten the nut until the capillary does not rotate. 4. Tighten the nut about ½ turn with a socket wrench. 	<p>Finger-tighten, then tighten an extra ¼ to ½ turn with a socket wrench.</p>

Preparing the perfect fitting connection

Problems such as peak tailing, peak broadening, split peaks and carryover challenge chromatographers working with HPLC and UHPLC. One common cause for those problems that is often overlooked and costs much time in troubleshooting is poor tubing connection. Dead volume or micro-leakage in tubing connections can greatly affect the performance and reproducibility of chromatographic analysis, especially with modern UHPLC and Fast LC columns.

Fitting connection requirements

Fitting connections can have a large impact on the peak shape of analytes. An ideal fitting connection should feature:

- Zero dead volume between tubing and receiving port
- Ability to remain free of leaks under ultrahigh pressures and elevated temperatures
- Robustness over long-term use, preventing tubing slippage
- Ease-of-use

Nonadjustable metallic fittings

Most commonly used fittings in UHPLC are nonadjustable 2-piece or 3-piece metallic fittings, which are permanent and nonadjustable after they have been assembled. Since different manufacturers of column hardware use different designs for column end fittings, a new set of tubing and fittings should be swaged for every brand of column. This ensures that the stem length, namely the length between the bottom of the ferrule and the end of the tubing, is perfectly matched.

Fitting connection design varies between different column manufacturers, and improper stem length of the fitting could cause leaks or poor peak shape. If the stem length is too short, a dead volume is created, resulting in deterioration of peak shape, lower resolution, and carryover. If the stem length is too long, the ferrule will not seat properly and leakage will occur. In addition, conventional fittings and ferrules are often over tightened when wrenches are used, resulting in the fitting getting permanently stuck in the column.

Swagelok

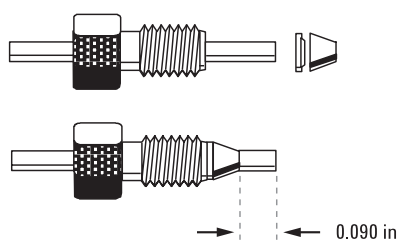

Waters (non-Acquity)

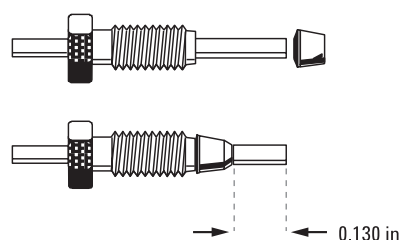

Parker

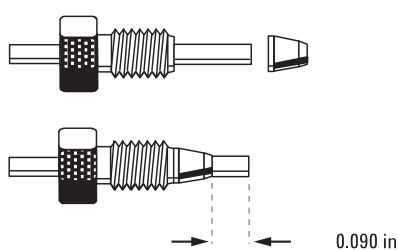

Rheodyne

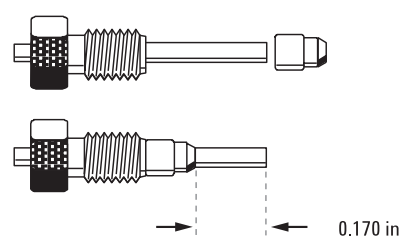

Valco

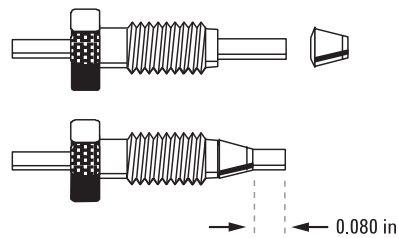

Upchurch (iDEX)

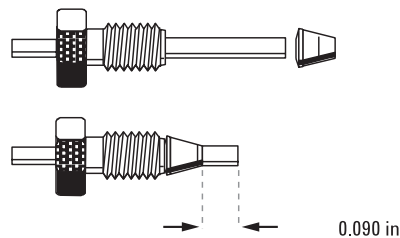

Adjustable finger-tight fittings

To solve the problems of conventional fittings, adjustable finger-tight fittings have been developed that are compatible with different columns. These fittings usually have polymer (for example, PEEK) ferrules, which make the fittings reusable because the ferrule is not permanently attached to the tubing. However, many of them still have some drawbacks, such as:

- The inability to reach 1300 bar ultrahigh pressures without tools
- The need to follow strict guidelines on the exact torque or range of turning angle to avoid over-tightening
- The need to check for leaks every time after reconnection
- The fitting often needs to be retightened
- The polymeric ferrule could slip off the receiving port at ultrahigh pressures or pressure cycling, leading to the creation of dead volume

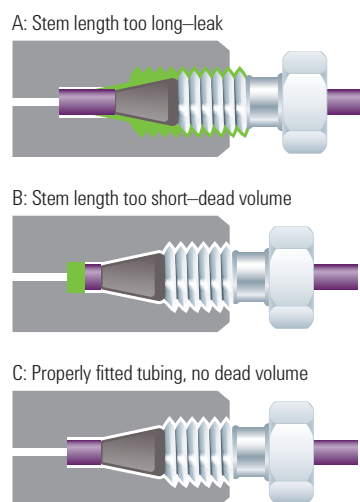

InfinityLab Quick Connect and Quick Turn fittings

InfinityLab Quick Connect and Quick Turn fittings avoid these drawbacks, enabling a reproducible and leak-free column connection. The Quick Connect fitting is for column connections with 1300 bar sealability without the need for a wrench. The Quick Turn fitting is for various flowpath connections, including column inlet/outlet, valve, and other connections. This fitting seals up to 600 bar by finger tightening (depending on users and positions of connection) and up to 1300 bar with a wrench.

Both types of fittings have a novel spring-loaded design that constantly pushes the tubing against the receiving port, delivering a reproducible connection with no dead volume for consistent chromatographic performance. The stem length is adjustable through the spring, which makes both fittings compatible with all types of LC columns. In addition, the Quick Connect fitting has a unique lever actuated design, so that the spring assembly, including the lever, applies a constant force that presses the ferrule onto the tubing, avoiding tubing slippage. Little force is required to tighten the fitting to 1300 bar (18,850 psi) without any tools.

To find out more about InfinityLab fittings, turn to **Pages 103–106**.

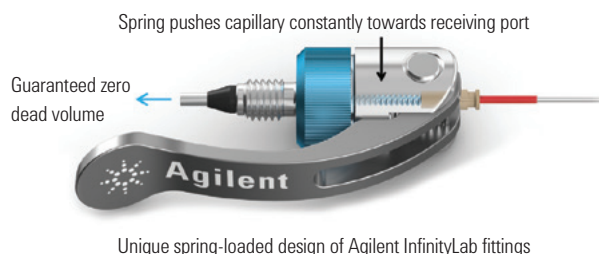

Unique spring-loaded design of Agilent InfinityLab fittings

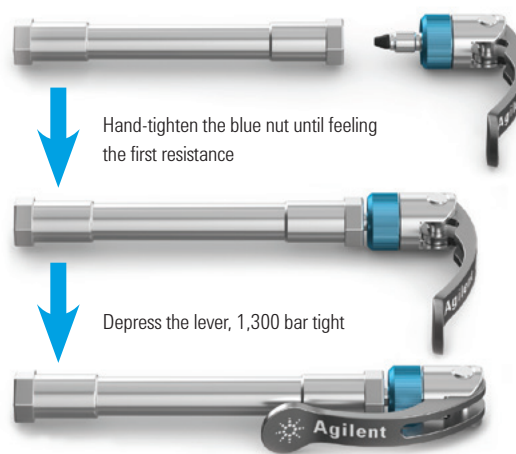

Installation of Agilent InfinityLab Quick Connect fitting

LC COLUMNS

Agilent InfinityLab LC columns deliver consistently high throughput and high-quality data, meaning that your lab can operate at peak efficiency.



InfinityLab Poroshell 120

InfinityLab Poroshell 120 columns are available in three different particle diameters allowing you to choose the size that best fits your separation needs. Because the different particles are engineered with a consistent core-to-particle size ratio, you can easily transfer a method developed on one particle size to any of the others.

InfinityLab Poroshell 120 columns provide exceptional efficiency, and significantly boost performance from all instruments, whether you have older 400 bar HPLC systems or newer 800 or 1300 bar UHPLC systems. Their advanced features include:

Excellent lot-to-lot reproducibility: A proprietary, single-step porous shell process dramatically reduces tiny differences between lots of columns, giving you confidence in your separation results.

A scalable family of particles: 1.9 μm , 2.7 μm , and 4 μm superficially porous particles enable you to get the best from your methods and instruments, and allow easy transfer between HPLC and UHPLC methods.

Easy method development: Up to *twelve* chemistries provide selectivity options for fast method development. What's more, alignment with ZORBAX chemistries makes it easier to transfer your methods.

Long column life: Robust particles are stable at required pressures. In addition, 2.7 μm and 4 μm columns with standard 2 μm frits resist plugging with dirty samples. UHPLC guard columns further extend the life of your analytical column.

Superior peak shape: High-purity silica and advanced bonding chemistries reduce peak tailing, especially at pH 6-7, and give you faster, more accurate results. For high pH methods, Poroshell HPH columns offer exceptional peak shape up to pH 11.

Easy traceability with InfinityLab Column ID tags: All InfinityLab Poroshell 120 columns are available with a permanently fitted ID tag that is preprogrammed with details of phase and dimensions. The column ID tag works seamlessly with InfinityLab Series LC instruments. The preprogrammed ID tag allows you to track various column properties and usage parameters including, but not limited to: column identity, lot and batch number, the last injection date, number of injections, and the maximum temperature used. These details allow chromatographers to get the most from their column and LC instrument.

Column Specifications

Solid Core	Porous Layer	Particle	Best for
1.2 μm	0.35 μm	1.9 μm	Highest UHPLC performance
1.7 μm	0.5 μm	2.7 μm	UHPLC performance at lower pressures
2.5 μm	0.75 μm	4 μm	Improved HPLC performance

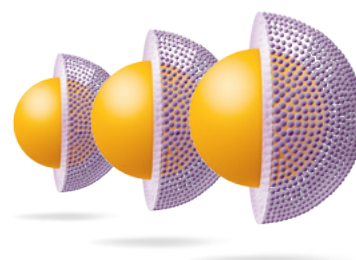

InfinityLab Poroshell 120 Columns

Size (mm)	Particle Size (µm)	Pressure Limit (bar)	EC-C18	EC-C8	Phenyl-Hexyl	SB-C18	SB-C8	HPH-C18	HPH-C8	Bonus-RP	PFP	SB-Aq	EC-CN	HILIC
3 x 150	1.9	13 00	693675-302	693675-306	693675-312			693675-502			693675-308			693675-301
3 x 100	1.9	1300	695675-302	695675-306	695675-312			695675-502			695675-308			695675-301
3 x 50	1.9	1300	699675-302	699675-306	699675-312			699675-502			699675-308			699675-301
2.1 x 150	1.9	1300	693675-902	693675-906	693675-912			693675-702			693675-408			693675-901
2.1 x 100	1.9	1300	695675-902	695675-906	695675-912			695675-702			695675-408			695675-901
2.1 x 50	1.9	1300	699675-902	699675-906	699675-912			699675-702			699675-408			699675-901
4.6 x 250	2.7	600	690975-902T											
4.6 x 150	2.7	600	693975-902T	693975-906T	693975-912T	683975-902T	683975-906T	693975-702T	693975-706T	693968-901T	693975-408T	683975-914T	693975-905T	693975-901T
4.6 x 100	2.7	600	695975-902T	695975-906T	695975-912T	685975-902T	685975-906T	695975-702T	695975-706T	695968-901T	695975-408T	685975-914T	695975-905T	695975-901T
4.6 x 75	2.7	600	697975-902T	697975-906T		687975-902T								
4.6 x 50	2.7	600	699975-902T	699975-906T	699975-912T	689975-902T	689975-906T	699975-702T	699975-706T	699968-901T	699975-408T	689975-914T	699975-905T	699975-901T
4.6 x 30	2.7	600	691975-902T	691975-906T		681975-902T								
3 x 150	2.7	600	693975-302T	693975-306T	693975-312T	683975-302T	683975-306T	693975-502T	693975-506T	693968-301T	693975-308T	683975-314T	693975-305T	693975-301T
3 x 100	2.7	600	695975-302T	695975-306T	695975-312T	685975-302T	685975-306T	695975-502T	695975-506T	695968-301T	695975-308T	685975-314T	695975-305T	695975-301T
3 x 75	2.7	600	697975-302T	697975-306T		687975-302T								
3 x 50	2.7	600	699975-302T	699975-306T	699975-312T	689975-302T	689975-306T	699975-502T	699975-506T	699968-301T	699975-308T	689975-314T	699975-305T	699975-301T
3 x 30	2.7	600	691975-302T	691975-306T		681975-302T								
3.0 x 100	2.7	1000	695575-302											
3.0 x 150	2.7	1000	693575-302											

(Continued)

TIPS & TOOLS

For the most accurate and reproducible results, use InfinityLab Quick Connect and Quick Turn fittings with your InfinityLab Poroshell 120 column to ensure an exact connection time after time.

Turn to **Pages 103–106** for more information.

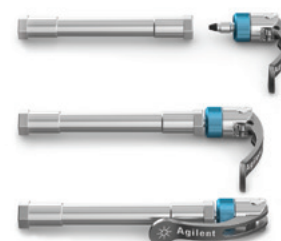

InfinityLab Poroshell 120 Columns

Size (mm)	Particle Size (µm)	Pressure Limit (bar)	EC-C18	EC-C8	Phenyl-Hexyl	SB-C18	SB-C8	HPH-C18	HPH-C8	Bonus-RP	PFP	SB-Aq	EC-CN	HILIC
2.1 x 150	2.7	600	693775-902T	693775-906T	693775-912T	683775-902T	683775-906T	693775-702T	693775-706T	693768-901T	693775-408T	683775-914T	693775-905T	693775-901T
2.1 x 100	2.7	600	695775-902T	695775-906T	695775-912T	685775-902T	685775-906T	695775-702T	695775-706T	695768-901T	695775-408T	685775-914T	695775-905T	695775-901T
2.1 x 75	2.7	600	697775-902T	697775-906T		687775-902T								
2.1 x 50	2.7	600	699775-902T	699775-906T	699775-912T	689775-902T	689775-906T	699775-702T	699775-706T	699768-901T	699775-408T	689775-914T	699775-905T	699775-901T
2.1 x 30	2.7	600	691775-902T	691775-906T		681775-902T								
2.1 x 100	2.7	1000	695575-902											
2.1 x 150	2.7	1000	693575-902											
4.6 x 250	4	600	690970-902T	690970-906T	690970-912T			690970-702T	690970-706T		690970-408T			690970-901T
4.6 x 150	4	600	693970-902T	693970-906T	693970-912T			693970-702T	693970-706T		693970-408T			693970-901T
4.6 x 100	4	600	695970-902T	695970-906T	695970-912T			695970-702T	695970-706T		695970-408T			695970-901T
4.6 x 50	4	600	699970-902T	699970-906T	699970-912T			699970-702T	699970-706T		699970-408T			699970-901T
3 x 250	4	600	690970-302T	690970-306T	690970-312T			690970-502T	690970-506T		690970-308T			690970-301T
3 x 150	4	600	693970-302T	693970-306T	693970-312T			693970-502T	693970-506T		693970-308T			693970-301T
3 x 100	4	600	695970-302T	695970-306T	695970-312T			695970-502T	695970-506T		695970-308T			695970-301T
3 x 50	4	600	699970-302T	699970-306T	699970-312T			699970-502T	699970-506T		699970-308T			699970-301T
2.1 x 250	4	600	650750-902T	650750-906T	650750-912T			690770-702T	690770-706T		650750-408T			650750-901T
2.1 x 150	4	600	693770-902T	693770-906T	693770-912T			693770-702T	693770-706T		693770-408T			693770-901T
2.1 x 100	4	600	695770-902T	695770-906T	695770-912T			695770-702T	695770-706T		695770-408T			695770-901T
2.1 x 50	4	600	699770-902T	699770-906T	699770-912T			699770-702T	699770-706T		699770-408T			699770-901T
4.6 x 250	4	600	690970-902	693970-906	690970-912			690970-702	690970-706		690970-408			690970-901
4.6 x 150	4	600	693970-902	695970-906	693970-912			693970-702	693970-706		693970-408			693970-901
4.6 x 100	4	600	695970-902	699970-906	695970-912			695970-702	695970-706		695970-408			695970-901
4.6 x 50	4	600	699970-902	690970-306	699970-912			699970-702	699970-706		699970-408			699970-901
3 x 250	4	600	690970-302	693970-306	690970-312			690970-502	690970-506		690970-308			690970-301
3 x 150	4	600	693970-302	695970-306	693970-312			693970-502	693970-506		693970-308			693970-301
3 x 100	4	600	695970-302	699970-306	695970-312			695970-502	695970-506		695970-308			695970-301

(Continued)

LC Column and Sample Prep Navigator

Find a more efficient replacement for your current column—or get recommendations for a new column, based on method parameters. www.agilent.com/chem/navigator

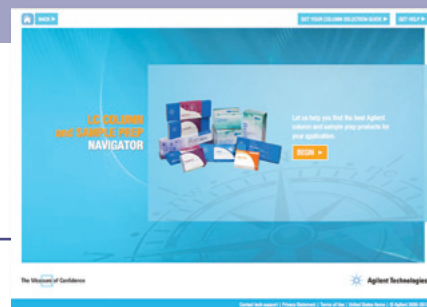

InfinityLab Poroshell 120 Columns

Size (mm)	Particle Size (µm)	Pressure Limit (bar)	EC-C18	EC-C8	Phenyl-Hexyl	SB-C18	SB-C8	HPH-C18	HPH-C8	Bonus-RP	PFP	SB-Aq	EC-CN	HILIC
3 x 50	4	600	699970-302	650750-906	699970-312			699970-502	699970-506		699970-308			699970-301
2.1 x 250	4	600	650750-902	693770-906	650750-912			690770-702	690770-706		650750-408			650750-901
2.1 x 150	4	600	693770-902	695770-906	693770-912			693770-702	693770-706		693770-408			693770-901
2.1 x 100	4	600	695770-902	699770-906	695770-912			695770-702	695770-706		695770-408			695770-901
2.1 x 50	4	600	699770-902		699770-912			699770-702	699770-706		699770-408			699770-901

InfinityLab Poroshell 120 – UHPLC Guard Columns

Size (mm)	Particle Size (µm)	Pressure Limit (bar)	EC-C18	EC-C8	Phenyl-Hexyl	SB-C18	SB-C8	HPH-C18	HPH-C8	Bonus-RP	PFP	SB-Aq	EC-CN	HILIC
3 x 5	1.9	1300	823750-940	823750-941	823750-943			823750-945			823750-942			823750-944
2.1 x 5	1.9	1300	821725-940	821725-941	821725-943			821725-945			821725-942			821725-944
4.6 x 5	2.7	600	820750-911	823750-913	820750-914	820750-912	820750-923	820750-921	820750-922	820750-925	820750-915	820750-924	820750-927	820750-926
3 x 5	2.7	600	823750-911	821725-913	823750-914	823750-912	823750-923	823750-921	823750-922	823750-925	823750-915	823750-924	823750-927	823750-926
2.1 x 5	2.7	600	821725-911	690970-906	821725-914	821725-912	821725-923	821725-921	821725-922	821725-925	821725-915	821725-924	821725-927	821725-926
4.6 x 5	4	600	820750-916					820750-930	820750-929					
3 x 5	4	600	823750-916					823750-930	823750-929					
2.1 x 5	4	600	821725-916					821725-930	821725-929					

Real stories from the lab.



TRUE STORY NO. **46**
FASTER, SIMPLER WORKFLOWS

During familiarization training for a new instrument, a CrossLab specialist helped a lab achieve extra productivity benefits through column consolidation.

Agilent
CrossLab

From Insight to Outcome

www.agilent.com/chem/story46

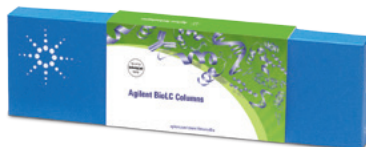

BioLC Columns

Part of the InfinityLab Family

The flexibility to achieve full biomolecule characterization requires a tool box of columns appropriate for large molecule separations. Whether you are analyzing intact proteins, protein fragments, peptide digests, amino acids, or oligonucleotides, Agilent offers a comprehensive range of columns in different pore sizes and particle morphologies designed for these complex separations. All are supported by expert technical support and application chemists around the globe. Agilent BioLC columns enhance the accuracy and speed of your biomolecule characterization by delivering:

- Increased speed to help you meet critical deadlines
- Ability to assess multiple critical quality attributes for multiple attribute monitoring (MAM)
- Increased resolution for accurate quantitation
- Increased sensitivity for confidence in your results
- Increased reproducibility to eliminate costly rework

Agilent BioLC columns are designed for optimum performance with InfinityLab bio-inert LC supplies.

NEED MORE INFORMATION?

Agilent has developed fully integrated biopharma workflow solutions to help resolve complex analytical challenges.

Increase productivity by analyzing the same number of samples without increasing resources or sacrificing data accuracy.

Search 5991-5235EN at www.agilent.com, or visit www.agilent.com/chem/biologics, to see how Agilent can help you solve these challenges.



BioLC Column Portfolio

This chart shows the common LC biomolecule characterization workflows and the recommended Agilent BioLC columns for each.

Protein identification and impurity profiling	Charged variant analysis	Aggregation analysis	Glycan analysis	Amino acid	Titer determination and purification	Oligonucleotides	Desalting Cartridges
Reversed-Phase	Ion Exchange	Size Exclusion	HILIC	Reversed-Phase	Affinity	Reversed-Phase	Reversed-Phase
PLRP-S	Bio MAb	AdvanceBio SEC	AdvanceBio Glycan Mapping	AdvanceBio Amino Acid Analysis	Bio-Monolith Protein A	AdvanceBio Oligonucleotides	AdvanceBio Desalting-RP
AdvanceBio RP-mAb	Bio IEX (SAX, SCX, WAX, WCX)	Bio SEC-3	ZORBAX RRHD 300-HILIC		Bio-Monolith Protein G		
AdvanceBio Peptide Mapping	PL-SAX	Bio SEC-5					
AdvanceBio Peptide Plus	PL-SCX	ProSEC 300S					
ZORBAX RRHD 300Å 1.8 µm	Bio-Monolith (QA, DEAE, SO ₃)						
Poroshell 300							
ZORBAX 300SB							



For a complete list of Agilent BioLC columns, or to order, please visit www.agilent.com/chem/advancebio

LC SYSTEMS

Advance with ease, at ease

Agilent InfinityLab LC Series systems are developed with up and downwards compatibility. So when you invest in an InfinityLab LC Series instrument, you can be assured of seamless integration into any laboratory using Agilent LC instruments. You can upgrade your current Agilent LC module-by-module over time, for stepwise increases in efficiency. What's more, Agilent InfinityLab supplies support this compatibility so you can adapt your system to your needs both now and in the future, protecting your investment.



Agilent 1290 Infinity II LC system

1290 Infinity II LC Series Modules

Module	Description
G7102A	1290 Infinity II evaporative light scattering detector
G7104A	1290 Infinity II flexible pump
G7114B	1290 Infinity II variable wavelength detector
G7116B	1290 Infinity II multicolumn thermostat
G7117A	1290 Infinity II diode array detector FS
G7117B	1290 Infinity II diode array detector
G7120A	1290 Infinity II high speed pump
G7129B	1290 Infinity II vialsampler
G7159B	1290 Infinity II preparative open-bed fraction collector
G7162B	1290 Infinity II refractive index detector
G7167B	1290 Infinity II multisampler
G7161B	1290 Infinity II preparative pump
G7163A	1290 Infinity II preparative column compartment
G7170B	1290 Infinity II MS flow modulator

1260 Infinity II LC Series Modules

Module	Description
G7110B	1260 Infinity II isocratic pump
G7111A	1260 Infinity II quaternary pump VL
G7111B	1260 Infinity II quaternary pump
G7112B	1260 Infinity II binary pump
G7104C	1260 Infinity II flexible pump
G7129A	1260 Infinity II vialsampler
G7114A	1260 Infinity II variable wavelength detector
G7115A	1260 Infinity II diode array detector WR
G7116A	1260 Infinity II multicolumn thermostat
G7117C	1260 Infinity II diode array detector HS
G7121A	1260 Infinity II fluorescence detector
G7121B	1260 Infinity II fluorescence detector spectra
G7826A	1260 Infinity II high temperature evaporative light scattering detector
G7122A	1260 Infinity II degasser
G7129C	1260 Infinity II vialsampler
G7162A	1260 Infinity II refractive index detector
G7165A	1260 Infinity II multiple wavelength detector
G7167A	1260 Infinity II multisampler
G5654A	1260 Infinity II bio-inert quaternary pump
G5668A	1260 Infinity II bio-inert multisampler
G1328C	1260 Infinity II manual injector
G1364F	1260 Infinity II analytical fraction collector
G7166A	1260 Infinity II preparative valve-based fraction collector
G7161A	1260 Infinity II preparative binary pump
G7157A	1260 Infinity II preparative autosampler
G1364E	1260 Infinity II preparative fraction collector
G9328A	1260 Infinity II preparative column organizer
G4782A	1260 Infinity II SFC binary pump
G4301A	1260 Infinity II SFC control module
G4767A	1260 Infinity II SFC multisampler



Agilent 1260 Infinity II LC system



Agilent 1290 Infinity LC system

Legacy LC Systems

Maintaining instrument performance and keeping operations running consistently are the foundations of maximizing lab productivity and efficiency. Which is why although these legacy instruments are no longer available to order Agilent is committed to supporting them. Thus ensuring that you can the achieve maximum possible performance from your legacy instruments.

1290 Infinity LC Series Modules

Module	Description
G1314E	1290 Infinity variable wavelength detector
G1316C	1290 Infinity thermostatted column compartment
G4204A	1290 Infinity quaternary pump
G4212A	1290 Infinity diode array detector
G4220A	1290 Infinity binary pump
G4220B	1290 Infinity binary pump VL
G4226A	1290 Infinity autosampler
G4227A	1290 Infinity flexible cube
G4261B	1290 Infinity evaporative light scattering detector
G4277A	1290 Infinity LC injector HTS
G4278A	1290 Infinity LC injector HTC

1260 Infinity LC Series Modules

Module	Description
G1310B	1260 Infinity isocratic pump
G1311B	1260 Infinity quaternary pump
G1311C	1260 Infinity quaternary pump VL (400 bar)
G1312B	1260 Infinity binary pump
G1312C	1260 Infinity binary pump VL (400 bar)
G1314B	1260 Infinity variable wavelength detector VL
G1314C	1260 Infinity variable wavelength detector VL+
G1314F	1260 Infinity variable wavelength detector
G1315C	1260 Infinity diode array detector VL+
G1315D	1260 Infinity diode array detector VL
G1316A	1260 Infinity thermostatted column compartment
G1321A	1260 Infinity fluorescence detector
G1322A	1260 Infinity standard degasser
G1328B	1260 Infinity manual injector
G1329B	1260 Infinity standard autosampler
G1361A	1260 Infinity preparative pump
G1362A	1260 Infinity refractive index detector
G1364B	1260 Infinity preparative-scale fraction collector
G1364C	1260 Infinity analytical-scale fraction collector
G1364D	1260 Infinity micro-scale fraction collector
G1365C	1260 Infinity multiple wavelength detector
G1365D	1260 Infinity multiple wavelength detector VL
G1367E	1260 Infinity high performance autosampler
G1376A	1260 Infinity capillary pump
G1377A	1260 Infinity high performance micro autosampler
G1379B	1260 Infinity micro degasser
G2226A	1260 Infinity nanoflow pump
G2258A	1260 Infinity dual loop autosampler
G2260A	1260 Infinity preparative autosampler
G4240A	1260 Infinity HPLC-chip cube interface
G4212B	1260 Infinity diode array detector
G4218A	1260 Infinity evaporative light scattering detector
G4225A	1260 Infinity high performance degasser
G4240A	1260 Infinity chip cube MS interface
G4260B	1260 Infinity evaporative light scattering detector
G5611A	1260 Infinity bio-inert quaternary pump
G5664A	1260 Infinity bio-inert analytical-scale fraction collector
G5667A	1260 Infinity bio-inert high-performance autosampler
G4302A	1260 Infinity SFC binary pump
G4301A	1260 Infinity SFC control module
G4303A	1260 Infinity SFC autosampler



Agilent 1260 Infinity LC system



Agilent 1200 Series Quaternary HPLC System

1200 Series LC Modules	
Module	Description
G1310A	1200 Series isocratic pump
G1311A	1200 Series quaternary pump
G1312A	1200 Series binary pump
G1312B	1200 Series binary pump SL (600 bar)
G1314B	1200 Series variable wavelength detector
G1314C	1200 Series variable wavelength detector SL
G1314D	1200 Series variable wavelength detector
G1314E	1200 Series variable wavelength detector SL+
G1315C	1200 Series diode array detector SL
G1315D	1200 Series diode array detector
G1316A	1200 Series thermostatted column compartment
G1316B	1200 Series thermostatted column compartment SL
G1321A	1200 Series fluorescence detector
G1322A	1200 Series vacuum degasser
G1328A	1200 Series manual injector
G1329B	1200 Series standard autosampler (thermostatted)
G1361A	1200 Series preparative pump
G1362A	1200 Series refractive index detector
G1364C	1200 Series preparative fraction collector
G1364B	1200 Series preparative scale fraction collector
G1364C	1200 Series analytical scale fraction collector
G1364D	1200 Series micro collector/spotter
G1365C	1200 Series multiple wavelength detector SL
G1365D	1200 Series multiple wavelength detector
G1367B	1200 Series high performance autosampler (400 bar)
G1367C	1200 Series high performance autosampler SL (600 bar)
G1367D	1200 Series high performance autosampler SL+ (600 bar)
G1376A	1200 Series capillary pump
G1377A	1200 Series microwell plate sampler
G1379B	1200 Series micro degasser
G1389A	1200 Series micro autosampler
G2226A	1200 Series nano pump
G2258A	1200 Series dual loop autosampler preparative scale
G2260A	1200 Series preparative autosampler
G4204A	1200 Series HPLC-Chip cube interface

1100 Series LC Modules

Module	Description
G1310A	1100 Series isocratic pump
G1311A	1100 Series quaternary pump
G1312A	1100 Series binary pump
G1313A	1100 Series standard autosampler
G1314A	1100 Series variable wavelength detector
G1315A/B	1100 Series diode array detector
G1316A	1100 Series thermostatted column compartment
G1321A	1100 Series fluorescence detector
G1322A	1100 Series vacuum degasser
G1328A	1100 Series manual injector
G1329A	1100 Series standard autosampler (thermostatted)
G1361A	1100 Series preparative pump
G1362A	1100 Series refractive index detector
G1364A	1100 Series analytical fraction collector
G1364B	1100 Series preparative fraction collector
G1365A/B	1100 Series multiple wavelength detector
G1367A	1100 Series well plate sampler
G1376A	1100 Series capillary pump
G1377A	1100 Series microwell plate sampler
G1379A	1100 Series micro degasser
G1389A	1100 Series micro autosampler
G2226A	1100 Series nano pump
G2258A	1100 Series dual loop autosampler preparative scale
G2260A	1100 Series preparative autosampler



Agilent 1100 Series HPLC System

PUT MORE THAN 40 YEARS OF RELENTLESS INNOVATION BEHIND YOUR EVERY RESULT

By continually raising the standards for technologies that support your routine analyses, Agilent's R&D efforts have led to breakthroughs such as:

- **New GC columns** that help you achieve higher levels of inertness and column-to-column reproducibility
- **LC column choices** that deliver the sensitivity and reliability you need for demanding applications
- **Cutting-edge sample preparation products** that promote reliable extraction and concentration
- **Fresh atomic and molecular spectroscopy ideas** for identifying and confirming targets and unknowns

Longtime Agilent customers have experienced our commitment firsthand. And now, we look forward to demonstrating how Agilent's approach to relentless innovation can work to your advantage, too.

CHEMICAL ANALYSIS SOLUTIONS



Food

From high-volume pesticide screening in food products to rapid identification of pathogens, Agilent understands the analytical needs of food producers, shippers, and regulators. Utilizing our easy-to-use analyzers and updated screening libraries, customers can quickly develop robust and reliable methods. Agilent's leading gas chromatography and mass spectrometry systems are widely regarded as valuable food testing techniques for an array of different analyses.



Environmental

Agilent offers more than 40 years of environmental testing and regulatory expertise. We help government and private labs with the full range of assays, from routine testing of soils for heavy metals to detection of pharmaceuticals in groundwater, in concentrations down to parts per trillion.



Energy & Chemicals

Agilent collaborates closely with process industry customers to offer analytical systems that meet their needs for separation, detection, throughput, and support. We'll even preconfigure custom or standard analyzers so they arrive at the lab ready-to-go. From crude oil, natural gas, and refining, to specialty chemicals and alternative fuels, Agilent provides the latest technologies and solutions to increase quality, safety, and profitability for energy and chemical labs, while meeting the industry's stringent quality requirements. Agilent leads the way in ASTM collaborations that have evolved—and will continue to evolve—into industry standards.



Forensics

Whether testing for poisons in a forensics investigation, screening athletes for performance enhancing drugs, analyzing samples for recreational drugs, or checking a crime scene for explosive residue—lives and professions may be dependent on the accuracy of your equipment. Agilent Technologies leads the industry with a comprehensive portfolio of workflow solutions that provide the ability to identify, confirm and quantify thousands of substances.



Lab Informatics

The ways labs capture, analyze and share data profoundly affect their efficiency. Agilent offers a rich, integrated suite of software products built on customer-driven architectural values with the Agilent OpenLAB software suite. OpenLAB delivers superior performance and connection across multiple systems, providing open systems integration and investment protection. Our commitment is to deliver more value across each step in the life cycle of scientific data—from data collection and analysis to interpretation and management.



Materials Science

Agilent offers a newly expanded portfolio of instruments used for the research, manufacturing and testing of advanced materials, from precision optics to pulp and paper. Tools for atomic spectroscopy, molecular spectroscopy, chromatography, and X-ray crystallography all support continuous progress in materials science.

LIFE SCIENCE SOLUTIONS



Biopharmaceutical

Biotherapeutics have enormous potential to improve human health, with growing numbers of protein and antibody therapeutics to address unmet medical needs. At every development stage, from disease research to QA/QC and manufacturing, Agilent can help you make the right choices for moving therapeutics to market. We understand the biopharmaceutical workflow so our product families work together seamlessly, as engines of research, discovery, and development. Agilent columns deliver complete characterization of biomolecules using reversed-phase, size exclusion, ion exchange, and affinity chromatography. Our bio-inert supplies ensure that every part of your workflow delivers the performance you need to optimize your bioseparation.



Pharmaceutical

You need the most efficient processes to evaluate drug candidates, determine efficacy, and ensure safety and compliance during development and manufacture. Agilent has worked with pharma companies for many years to ensure reliability and reproducibility for regulatory compliance, from lab-to-lab and around the world. Our pharma solutions provide high-throughput capability at every stage of the product life cycle, with automated sample preparation, industry-leading U/HPLC systems, the largest family of Fast LC columns, open access LC/MS, spectroscopy, and automated dissolution. A complete family of LC supplies and lamps help optimize every analysis and take day-to-day lab efficiency one step further.

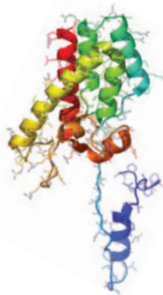

Proteomics

Research into how large sets of proteins affect the health of an organism requires special sets of analytical tools. Agilent has built a formidable arsenal of liquid chromatograph/mass spectrometers, bioinformatics systems, multiple affinity protein removal columns, and OFFGEL electrophoresis for protein identification and protein biomarker discovery. Accurate-Mass mass spectrometry and the microfluidic HPLC-Chip/MS are two Agilent innovations speeding the work of proteomics researchers around the globe.

Metabolomics

Collections of small molecules are increasingly being seen as rich sources of biomarkers, but studying metabolites presents many challenges. The need for speed, accuracy, and powerful interpretation capabilities in looking at chemical profile snapshots is underscored because molecules are constantly entering, leaving or changing within the metabolome. Agilent's GC, LC, and MS portfolios, along with our excellent bioinformatics offerings, user-customizable METLIN metabolite database for LC/MS, and the industry's first commercial GC/MS retention time locked metabolite library align well with the needs of metabolomics researchers.

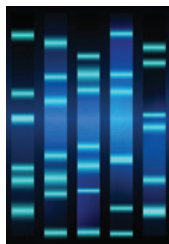

Genomics

Agilent is a global leader in microarrays, scanners, and NGS reagents used in a wide variety of genomic-based disease research experiments. Our SureSelect and HaloPlex Target Enrichment Systems dominate the category, streamlining next-generation sequencing studies. Agilent offers a wide range of catalog CGH and gene expression microarrays and a highly developed capability to produce custom arrays using our free online design tool, SureDesign. All Agilent microarrays feature highly sensitive, selective 60-mer probes, and, with as many as eight arrays printed on a slide, the cost-per-sample is cost-efficient.



Life Science Informatics

Mirroring its extensive instrument portfolio, Agilent offers the industry's most extensive suite of bioinformatics software, helping users derive knowledge from complex genomic, proteomic, metabolomic and other biological data. SureCall and CytoGenomics software analyzes NGS and aCGH data and the GeneSpring suite provides multi-omic analysis and visualization capabilities to help compare complex datasets to explore biological questions from multiple perspectives. The GeneSpring suite includes the GX module for microarray-based gene expression and genotyping data, the PA module for Pathway Analysis and multi-omic analysis and the MPP software, which analyzes mass spec data from proteomics and metabolomics experiments.



Lab Automation

To meet the skyrocketing demand for more throughput and automation, Agilent has substantially expanded its lab automation offerings. The Agilent line of liquid handlers and microplate processors are designed to streamline high-volume life science workflows. Agilent is also continually upgrading its advanced autosamplers for LC, GC, LC/MS, and GC/MS, adding functionality and speed to reflect the performance of its advanced instruments.



Vacuum Technology

Agilent works with customers to solve vacuum challenges from experiments in high-energy physics to developing systems for nanotechnology. Agilent manufactures vacuum systems used in its own mass spectrometry instruments as well as those of other manufacturers. Agilent's vacuum technology has been proven by the most powerful physics experiment ever built, CERN's Big Bang machine, which was used in the discovery of the Higgs boson.

Focus on what you do best

For over 40 years, Agilent has been building and maintaining the instruments you count on to stay competitive and successful. Trust us to protect your investment with a broad portfolio of services, backed by a global network of experienced service professionals dedicated to the productivity of your lab.

Agilent CrossLab Service Plans

The best service available for your Agilent instruments

Agilent offers a flexible range of service plans so that you can choose the level of coverage that is best for your lab.

- **Agilent CrossLab Gold**—Priority-one coverage for ultimate uptime and productivity
- **Agilent CrossLab Silver**—Comprehensive coverage for dependable laboratory operations
- **Agilent CrossLab Bronze**—Total repair coverage at a fixed annual price

Agilent service plans include Agilent Remote Advisor for real-time remote monitoring and diagnostics. Through secure internet connections, you can interact with Agilent service professionals, receive detailed asset reports, and configure text or email alerts to notify you before problems occur—helping you to maximize instrument uptime and optimize laboratory workflows.

Agilent Compliance Services

Equipment qualification that meets the most stringent requirements

Enterprise Edition Compliance was developed to streamline qualification delivery compliance across your entire lab. Used worldwide in regulated labs, including standards organizations and regulatory agencies, Enterprise Edition enables you to:

- Improve qualification efficiency by harmonizing protocols across platforms to ensure greater efficiency and minimize regulatory risk
- Standardize your entire compliance operation with robust test designs that work with all your instruments
- Add, remove, or reconfigure tests based upon your unique user requirements
- Reduce staff review time significantly with consistently formatted, computer generated, tamper-proof reports



Get the Agilent Service Guarantee

Should your instrument require service while covered by an Agilent Advantage service agreement, we guarantee repair or we will replace your instrument for free.

No other company offers this level of commitment to keep your lab up and running at peak efficiency.

Agilent Education and Consulting Services

Our best minds, working for you

Make the most of your instrument with training and consulting from the same experts who designed the instruments, software, and processes you use every day.

- Classroom, online, and onsite training in instrument operation, troubleshooting and maintenance
- Customized consulting services to meet your labs unique needs

The Agilent Value Promise—10 Years of Guaranteed Value

In addition to continually evolving products, we offer something else unique to the industry—our 10-year value promise guarantee. The Agilent Value Promise guarantees you at least 10 years of instrument use from your date of purchase, or we will credit you with the residual value of the system toward an upgraded model. Not only does Agilent ensure a reliable purchase now, but we also ensure that your investment is just as valuable in the future.

For more detailed information, please go to www.agilent.com/chem/services or contact your local Agilent Services and Support representative.



Technical Support at work for you

Have a hardware, software, application, instrument repair, or troubleshooting question? Agilent's technical experts are available to answer your questions. With years of laboratory experience, our technical support specialists can provide in-depth knowledge and experience.

For questions pertaining to supplies found in this catalog, contact your local Agilent office or Authorized Agilent Distributor or visit www.agilent.com/chem/techsupport

Need more information?

Visit www.agilent.com/chem/contactus to:

- Locate your nearest Agilent office or distributor for expert technical support
- Get fast sales and product assistance by phone. Simply use the scroll-down menu to select your country.
- Receive e-mail assistance using our convenient online forms

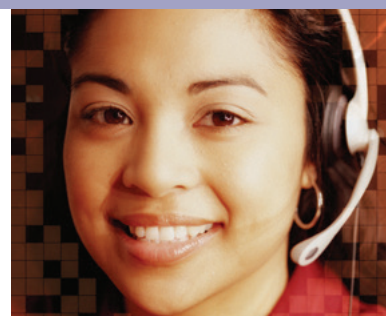



Agilent
CrossLab
From Insight to Outcome

**ACROSS THE LAB, AROUND THE WORLD,
WITH YOU EVERY STEP OF THE WAY.**

Contact us:

www.agilent.com/chem/contactus

Buy online:

www.agilent.com/chem/store

Get social with Agilent:

www.agilent.com/chem/social

Explore our full range of catalogs:

www.agilent.com/chem/catalog

For Research Use Only. Not for use in diagnostic procedures.

This information is subject to change without notice.

© Agilent Technologies, Inc. 2017

Published in the USA, September 10, 2017

5991-8031EN



Agilent Technologies